

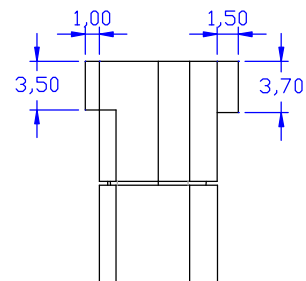

—  
—  
—

--	--	--	--

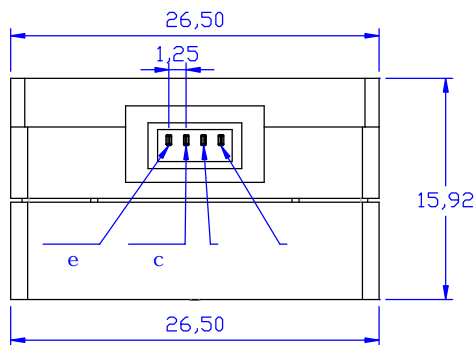

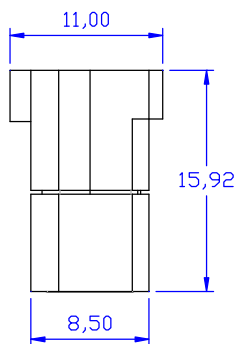
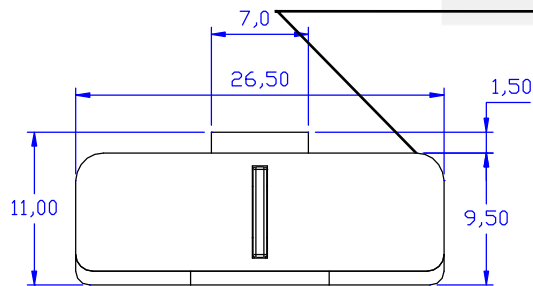
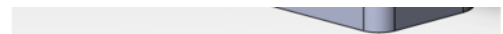
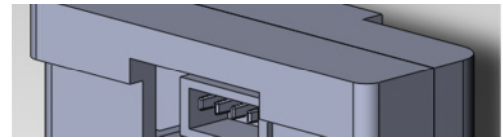
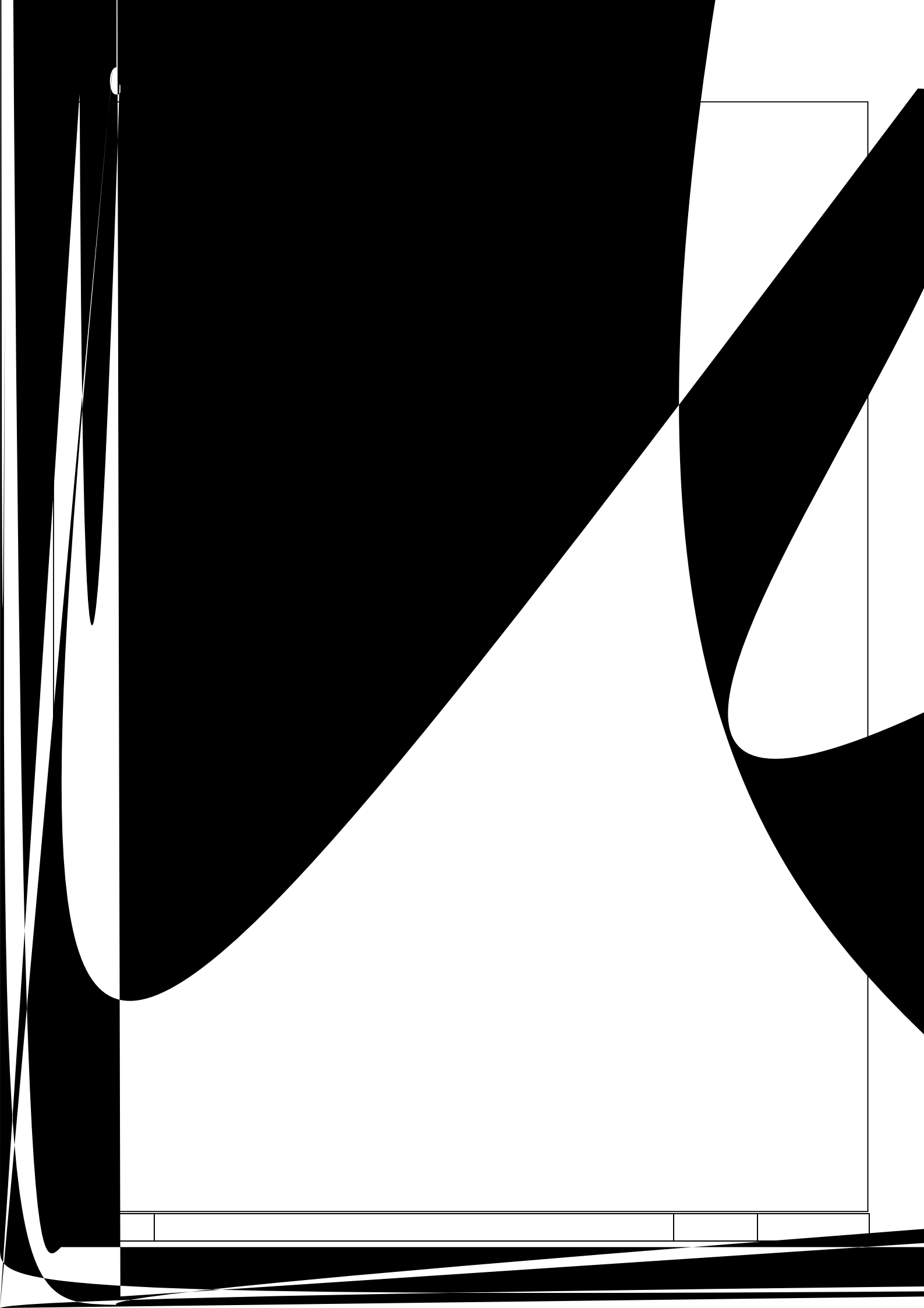

Peak Wavelength	p	---	940	---	nm	I

		---	15	---	μs	= 1K
		---	15	---	μs	