

## DATA SHEET

SPEC. NO. : SZ18032809  
DATE : 2021/10/17  
REV. : A/1

Approved By:

Checked By:

Prepared By:



LIG

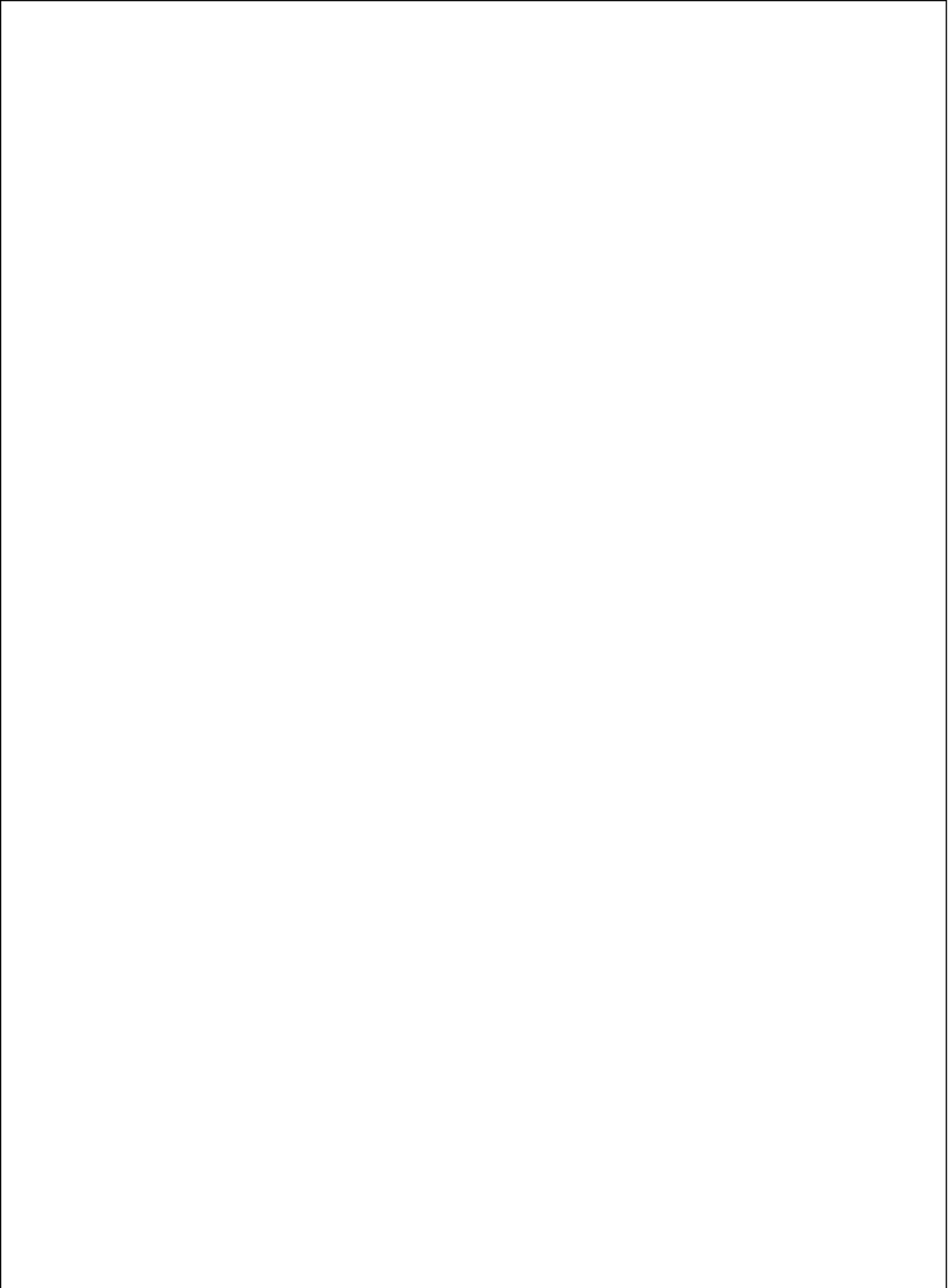

--	--	--	--

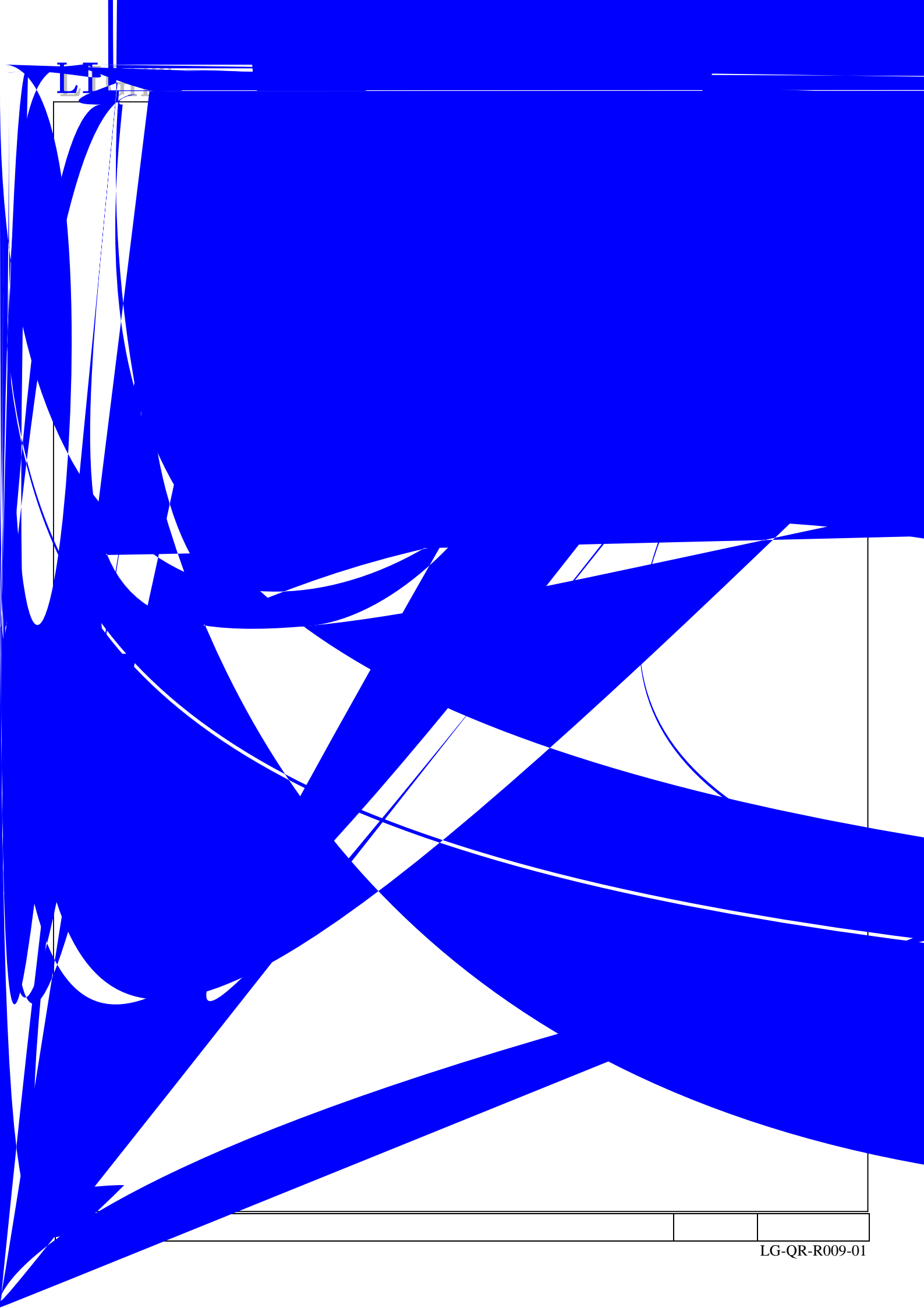

LI

Chromaticity Coordinates (Ta=25°C, IF=20mA)

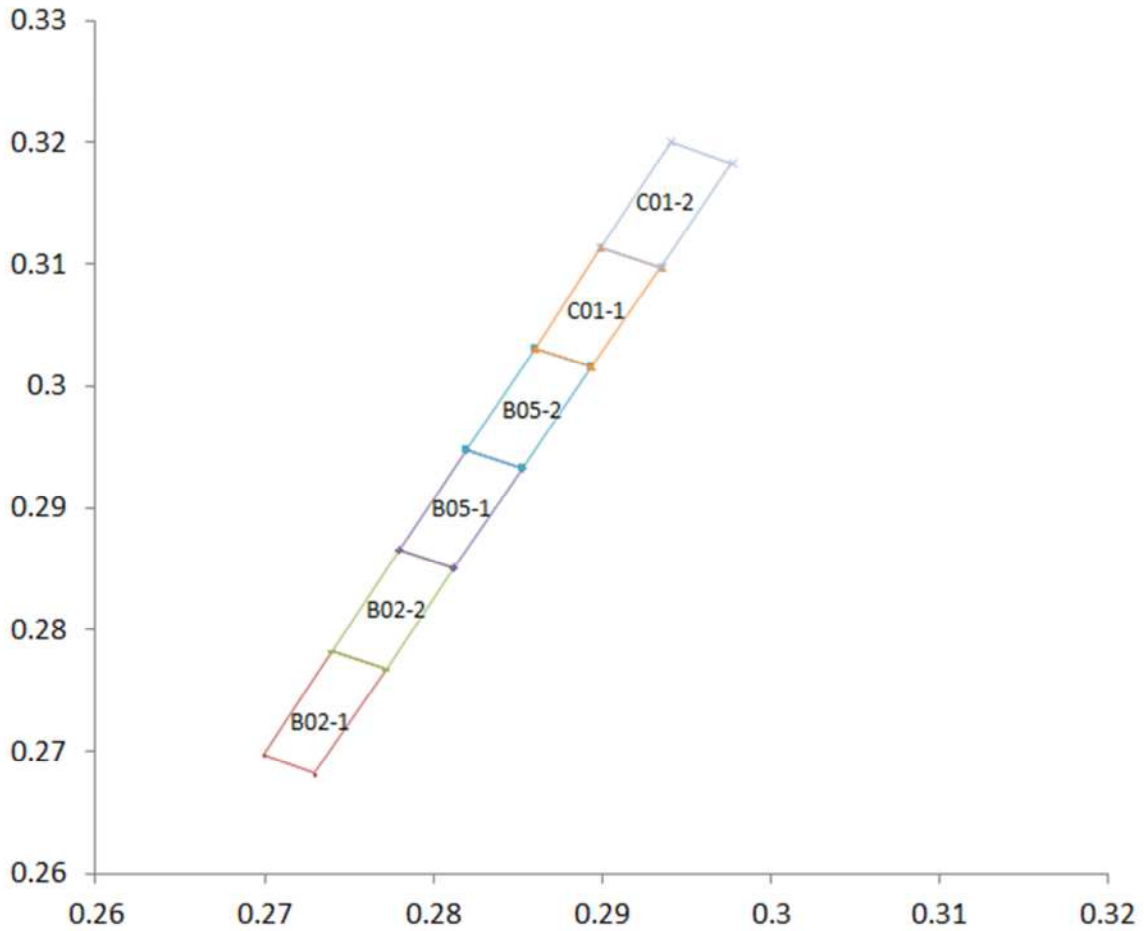

色区坐标	X1	Y1	X2	Y2	X3	Y3	X4	Y4
B02-1	0.2729	0.2682	0.2699	0.2697	0.2740	0.2783	0.2772	0.2768
B02-2	0.2772	0.2768	0.2740	0.2783	0.2780	0.2866	0.2812	0.2850
B05-1	0.2812	0.2850	0.2780	0.2866	0.2820	0.2948	0.2853	0.2932
B05-2	0.2853	0.2932	0.2820	0.2948	0.2860	0.3031	0.2894	0.3015
C01-1	0.2894	0.3015	0.2860	0.3031	0.2899	0.3114	0.2935	0.3097
C01-2	0.2935	0.3097	0.2899	0.3114	0.2941	0.3200	0.2977	0.3182

LI

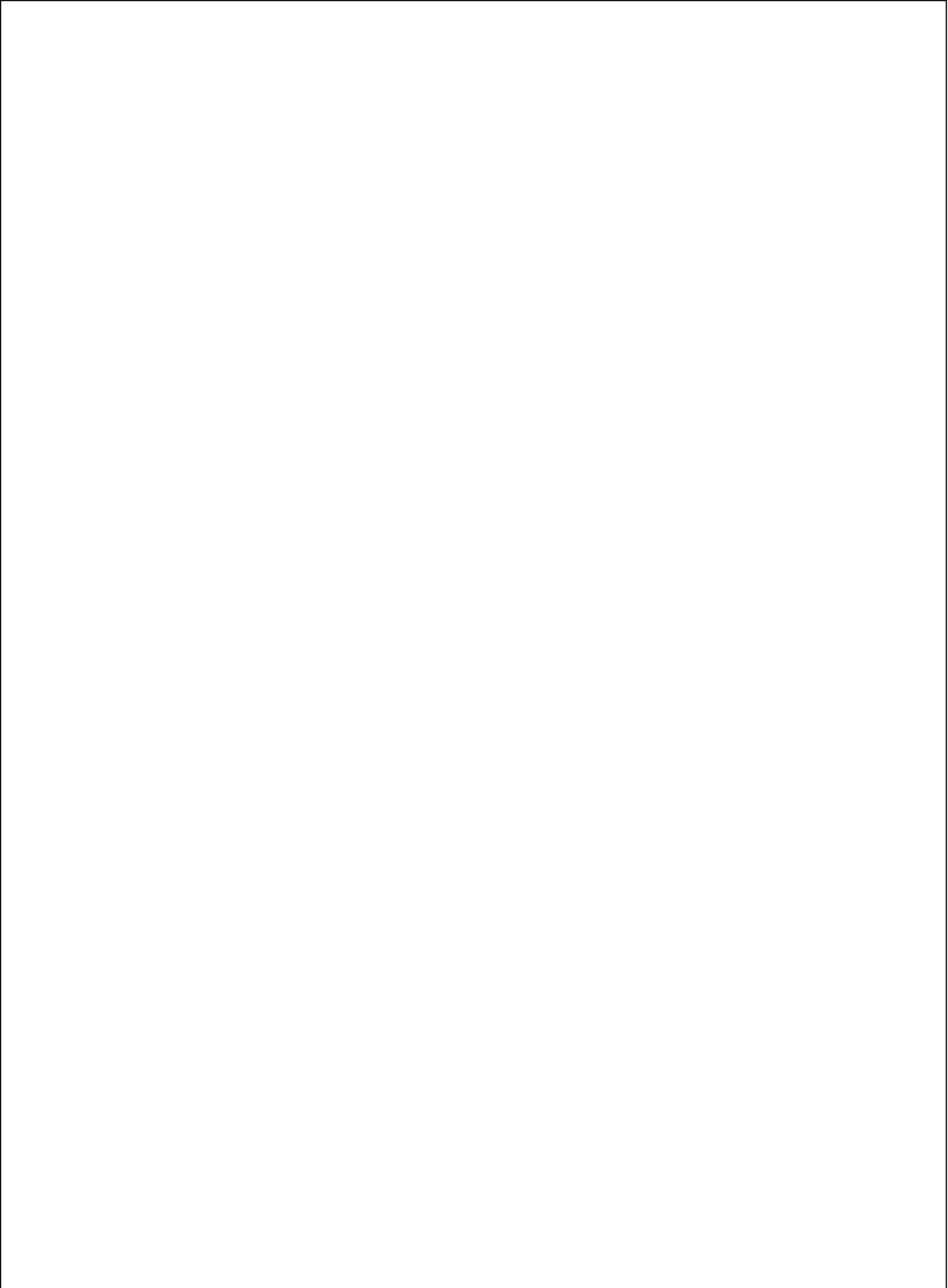

--	--	--	--

## Label Explanation

LIGHT Universal Label

<b>LIGHT</b> Light Electronics CO., LTD.	
MODEL NAME: _____	 LOT NO. : _____
QUANTITY: _____	
BIN: _____	
PACKING DATE: _____	
REMARKS: _____	

Customer Defined Label



## Reel Dimensions

Tolerance unless mentioned is  $\pm 0.2\text{mm}$ ; Unit = mm

--	--	--	--

## Carrier Tape Specifications (Loaded Quantity: 1000 pcs/roll)

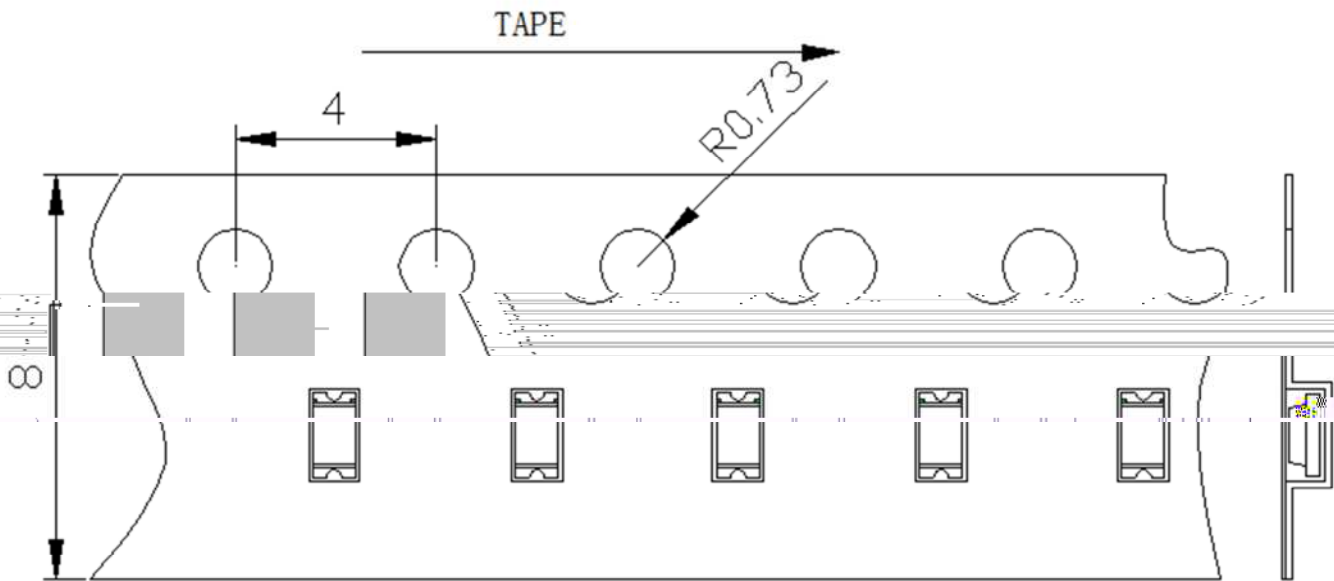

## Moisture Resistant Packaging

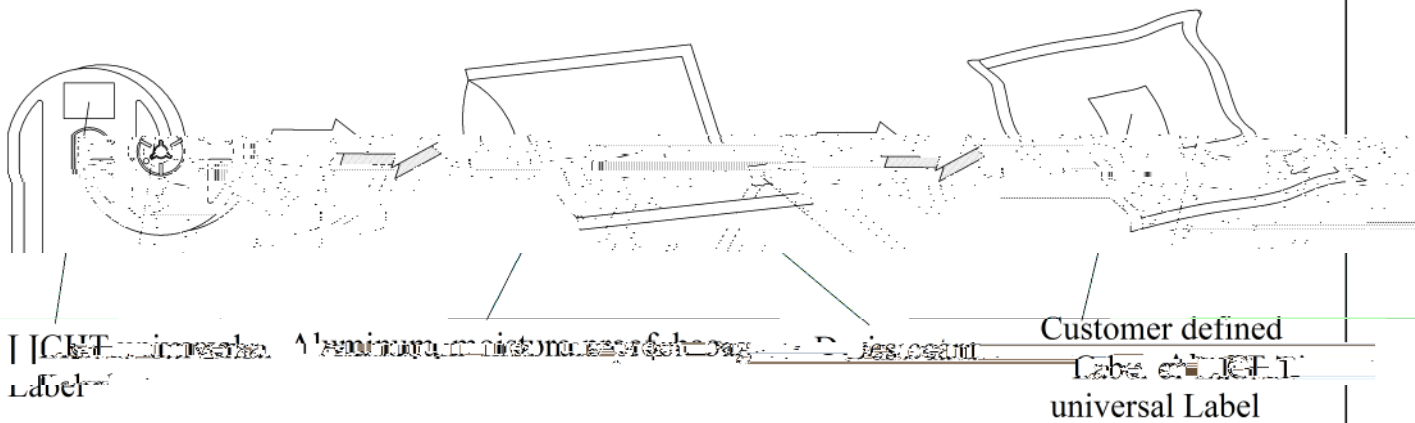



## Suggest IR Reflow Condition For Lead Free

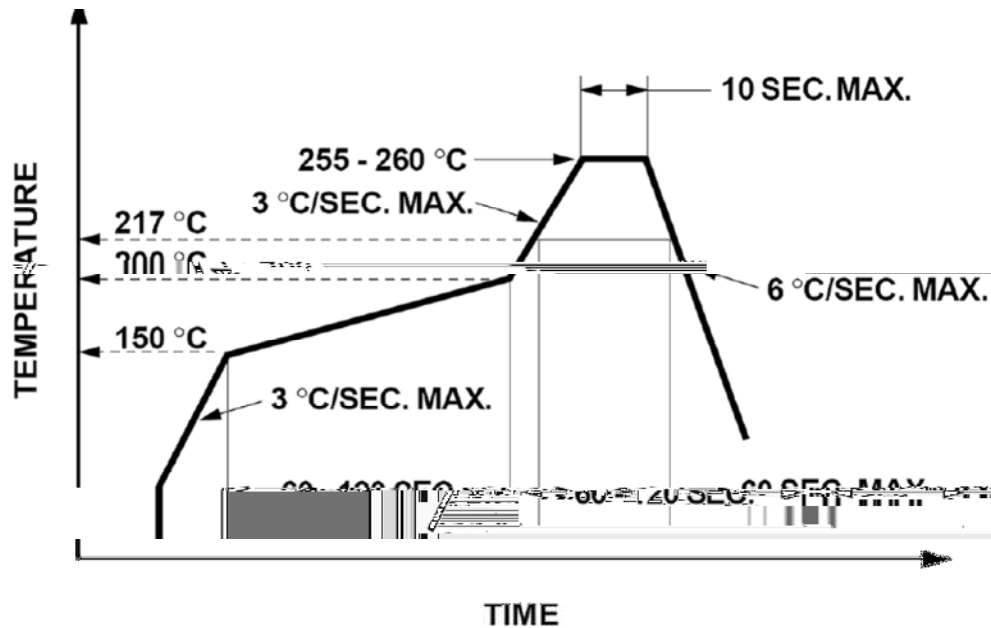

1. Reflow soldering should not be done more than two times.
2. When soldering, do not put stress on the LEDs during heating.

## Soldering iron

1. When hand soldering, the temperature of the iron must less than 300 °C for 3 seconds.
2. The hand solder should be done only once.

## Repairing

Repair should not be done after the LEDs have been soldered. When repairing is unavoidable, a double-head soldering iron should be used (as below figure). It should be confirmed beforehand whether the characteristics of LEDs will or will not be damaged by repairing.

