

LIGHT

Features

Pb free product
High Photo Sensitivity
Reliable and rugged
Long life – solid state
Sensitivity angle

Package Dimensions



SL-T423

Notes:

1. All dimensions are in millimeters.
2. Tolerance is ±0.1mm.
3. Specification is per MIL-STD-883C.

Part No. SL-T423

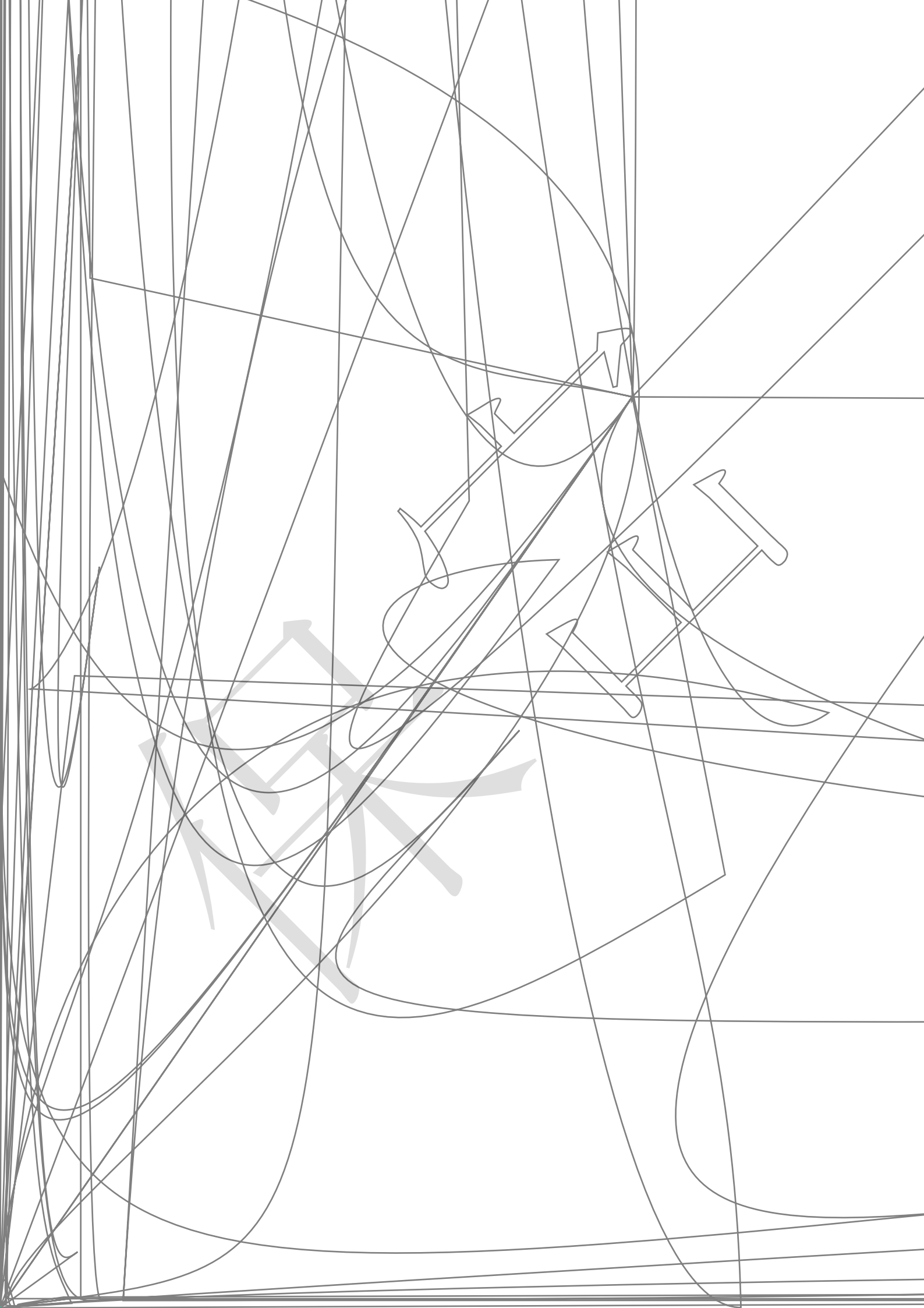

LIGHT

Typical Electrical / Optical Characteristics Curves (25 Ambient Temperature Unless Otherwise Noted)

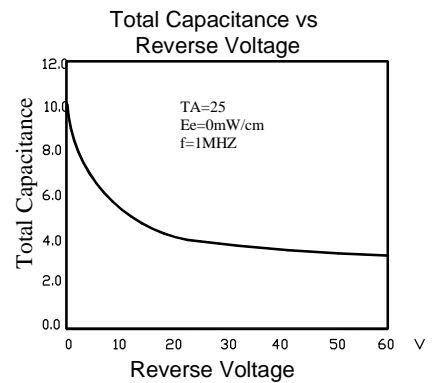
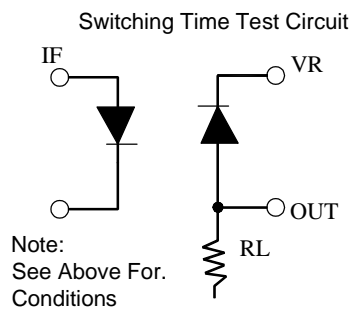
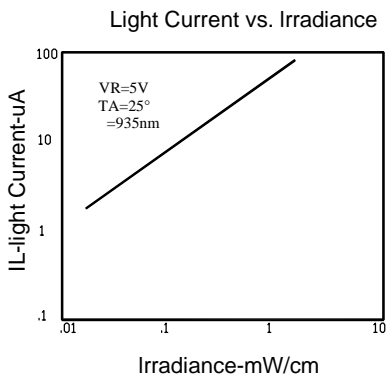
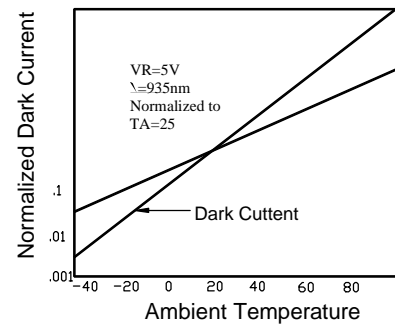
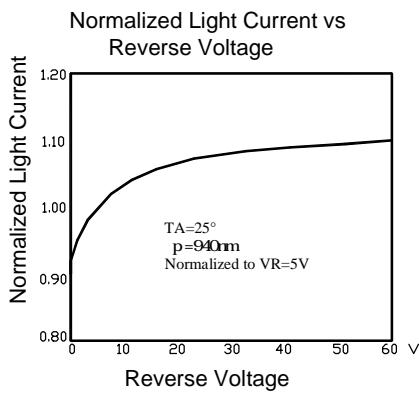
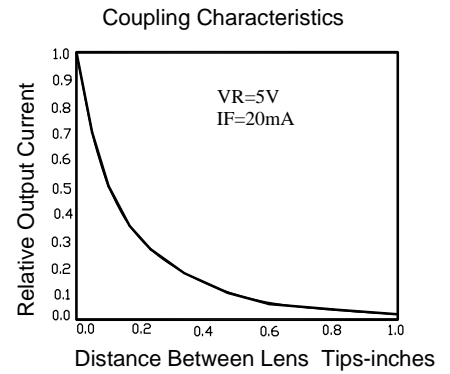
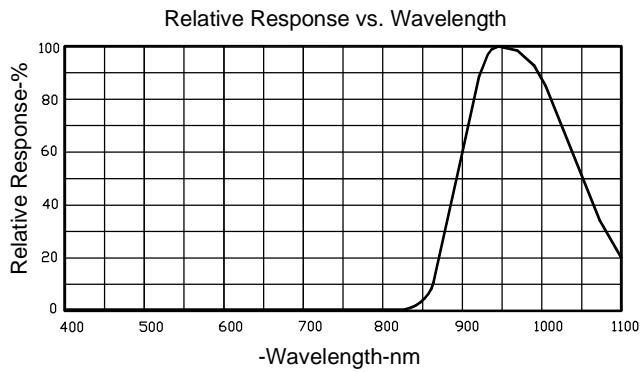

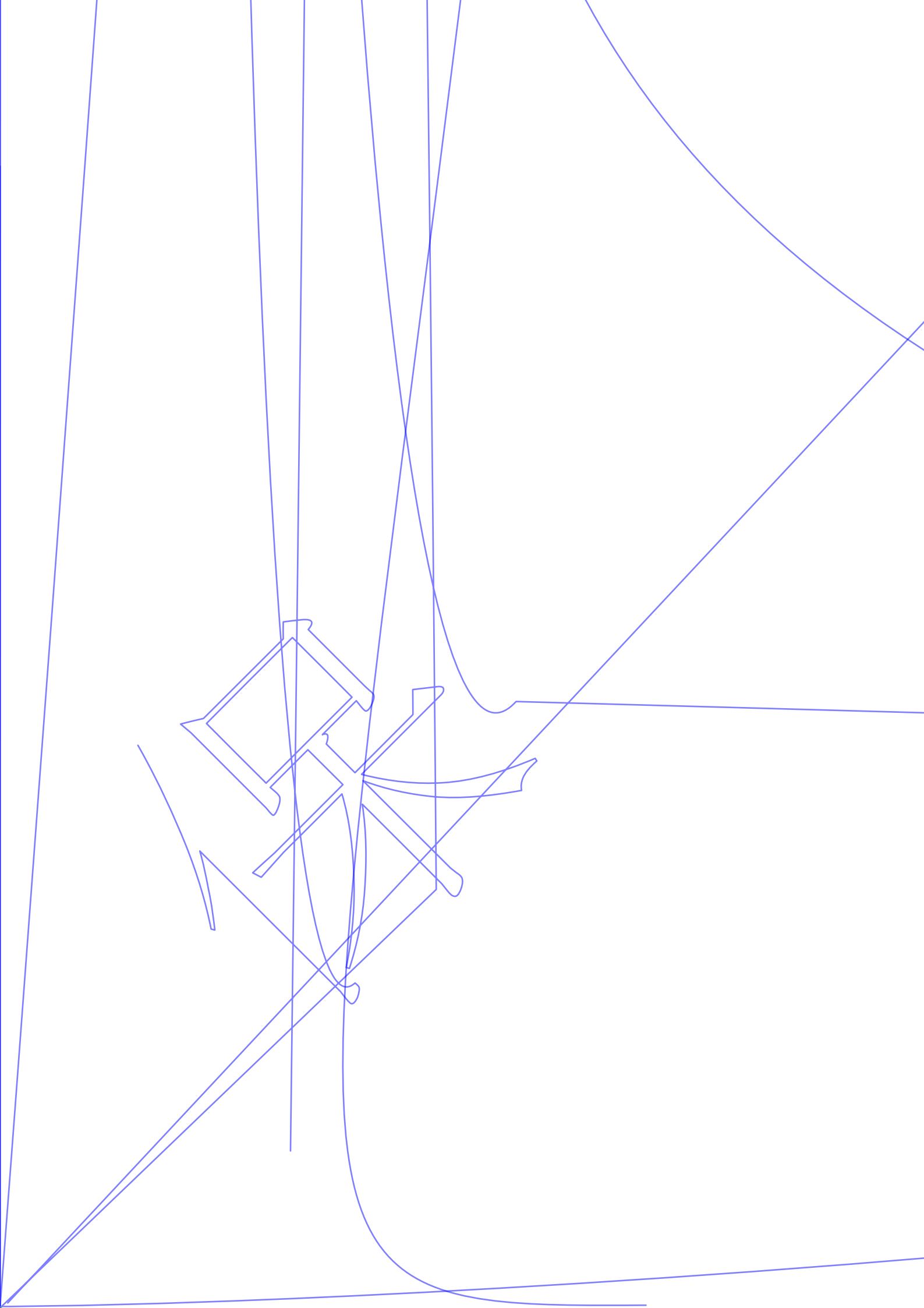

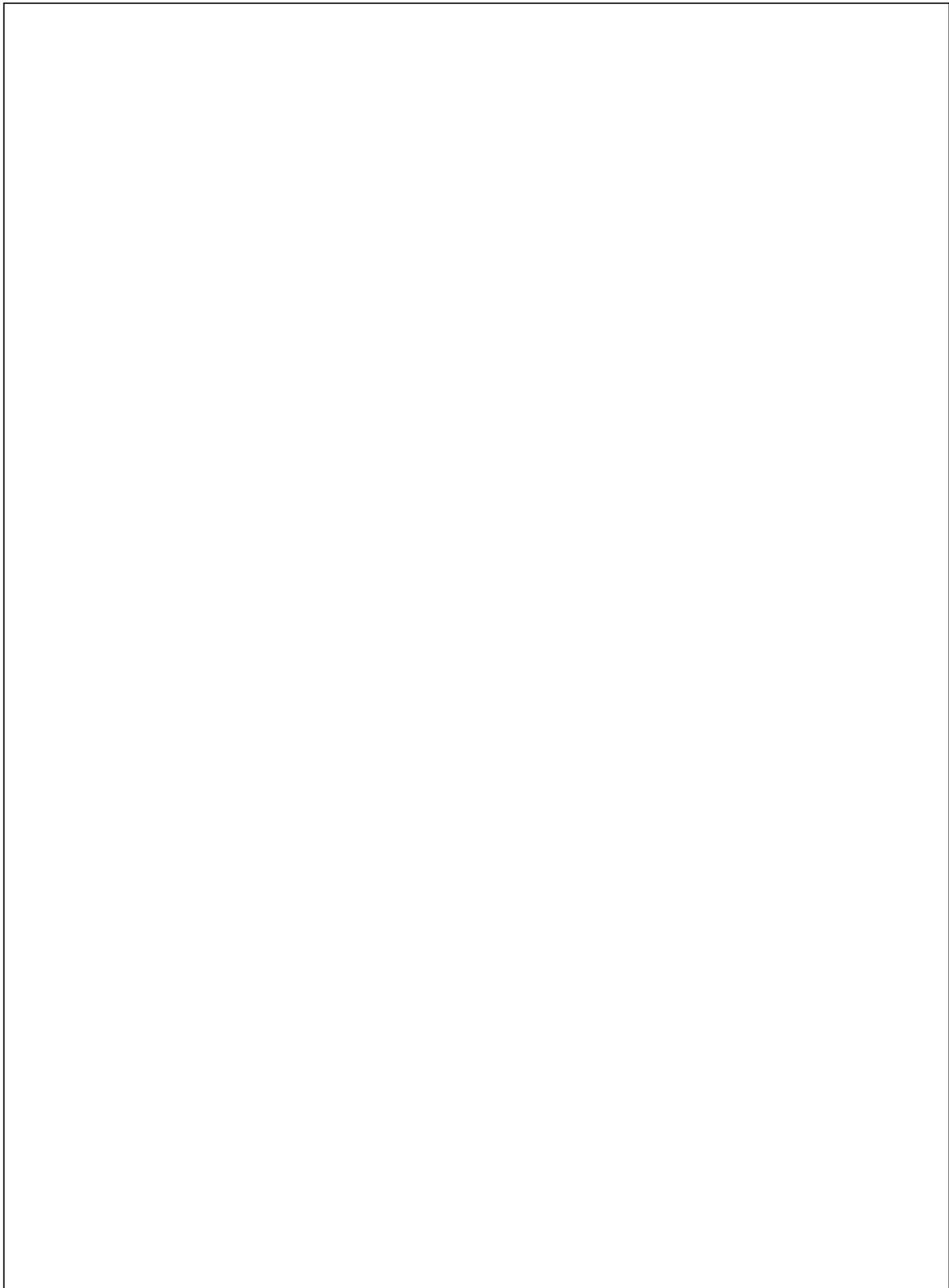

Part No.	SL-T4232PDB020-L415	Page	7 of 9
-----------------	----------------------------	-------------	---------------

