



LIGHT

ELECTRONICS CO., LTD.

LG-IRM2B238KSF3

IC

PIN

RoHS REACH

2.7-5.5V

TTL CMOS

( MP3 MP4, )

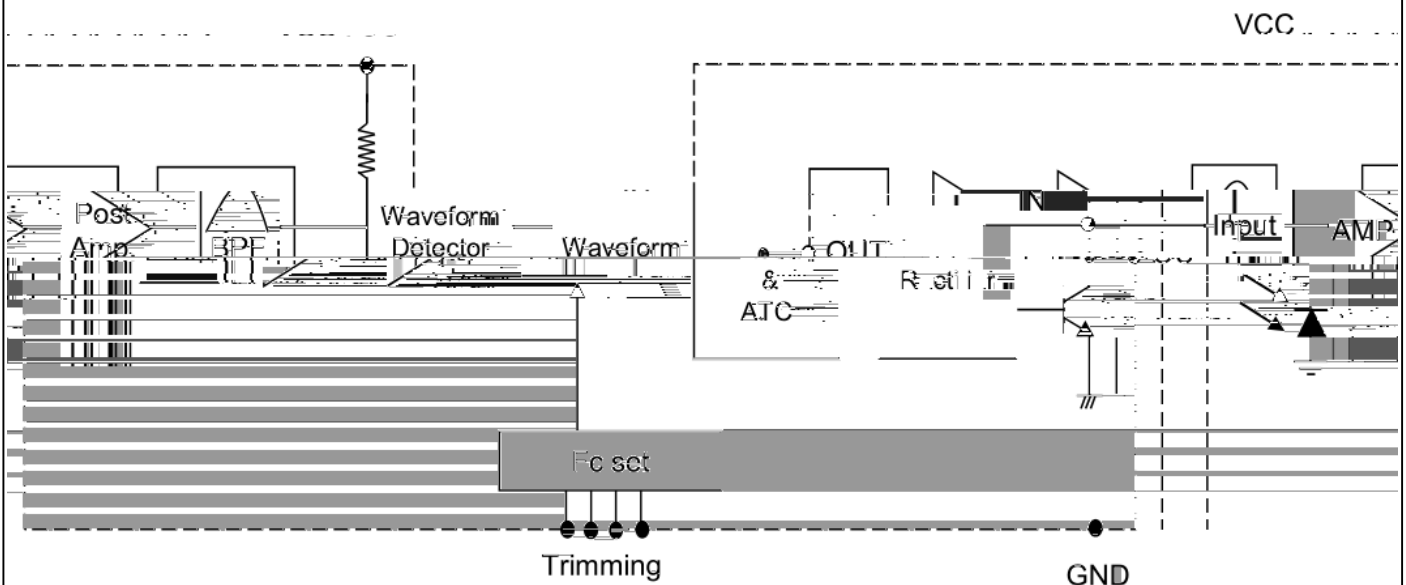
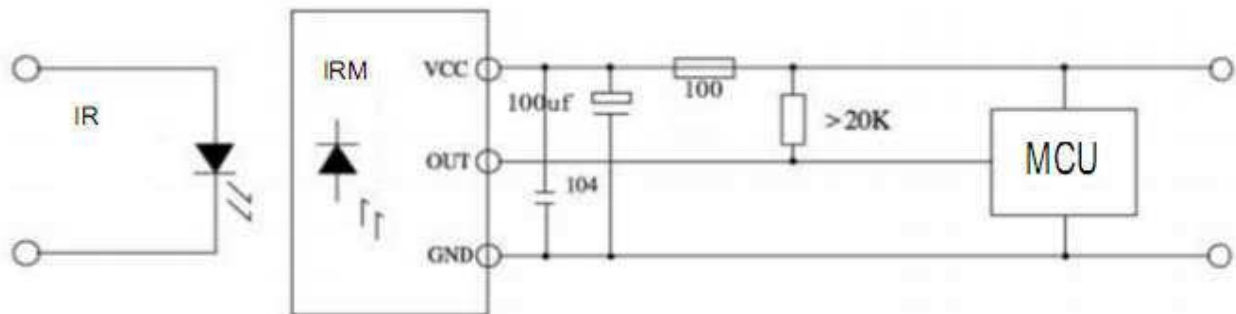
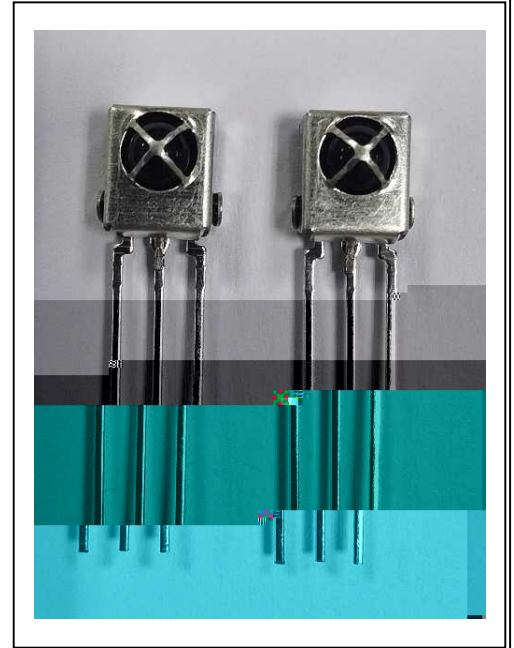



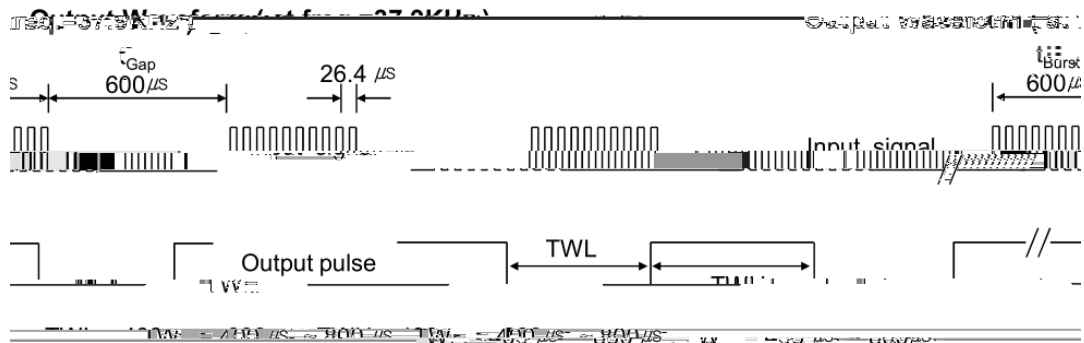

\*  $t_{pi} \geq 10/f_0$  is recommended for optimal function.

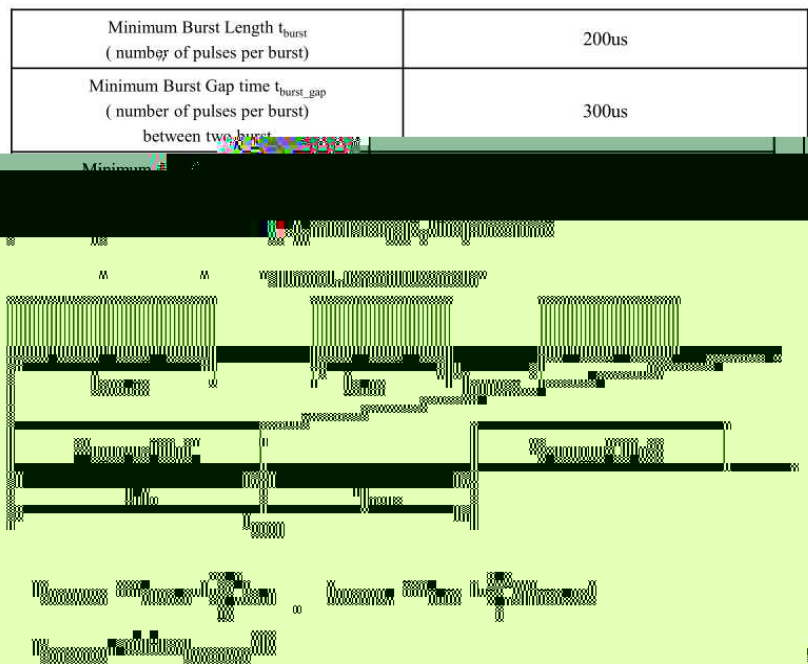

	260 ±5	5	20	20
	100PF, 1.5k , 4KV,	---	20	20
	10-50Hz/1min 1.5mm X Y Z/30min	30	20	20
	85 ±3	240	20	20
	-20 ±3	240	20	20
	85 85%	240	20	20
	-20 30 85 30	10	20	20
	2.5N 2	---	20	20

LIC

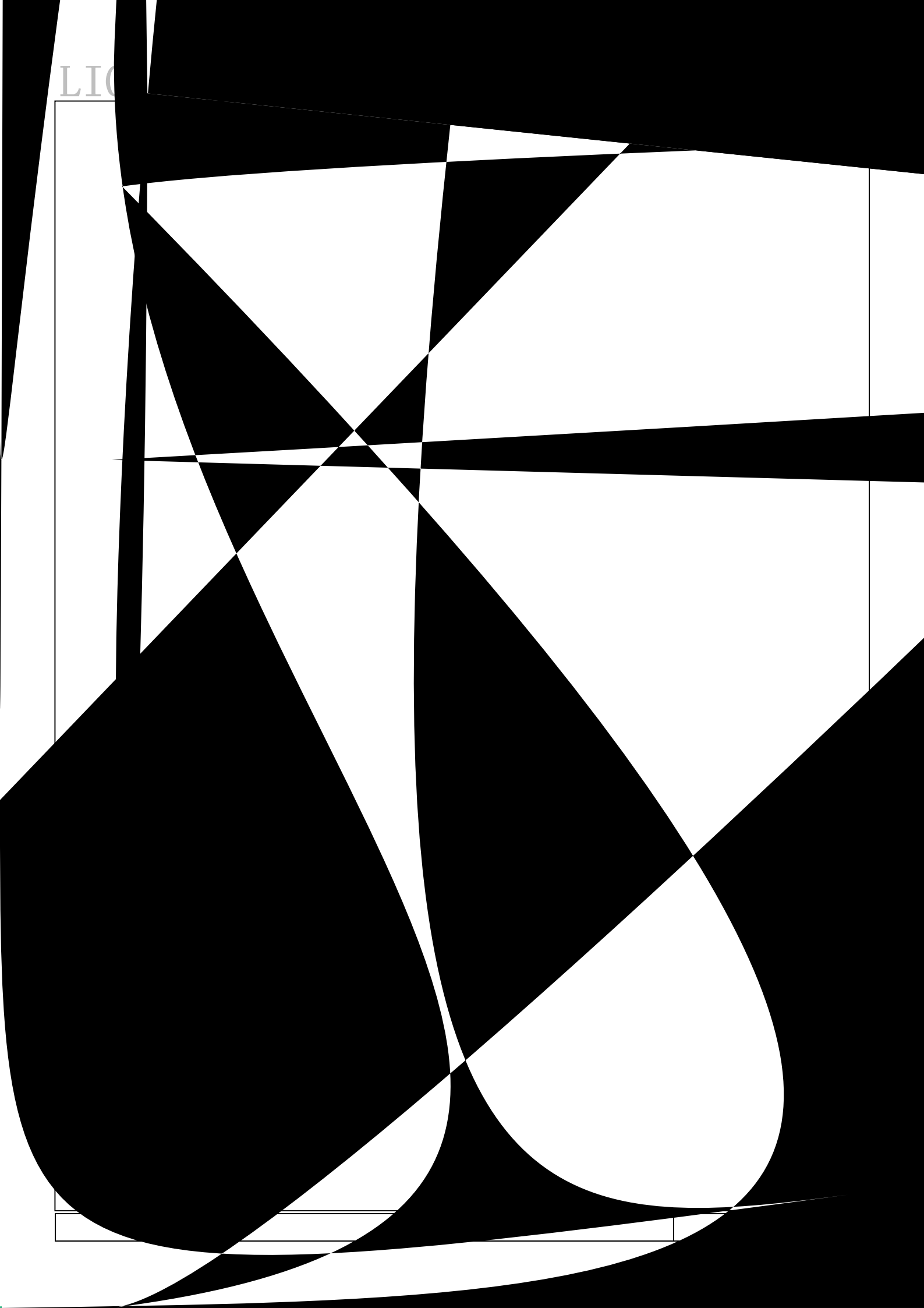

1

150mm × 190mm

500PCS

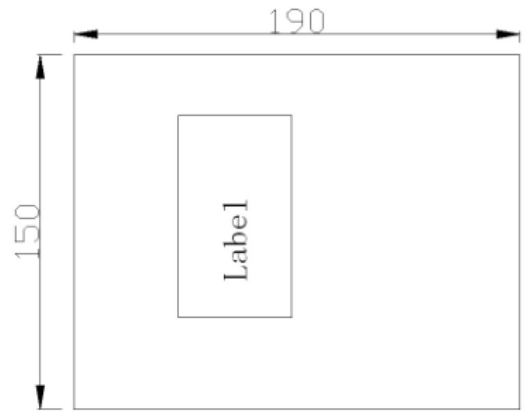

2

500pcs/

10 /

4 /

