

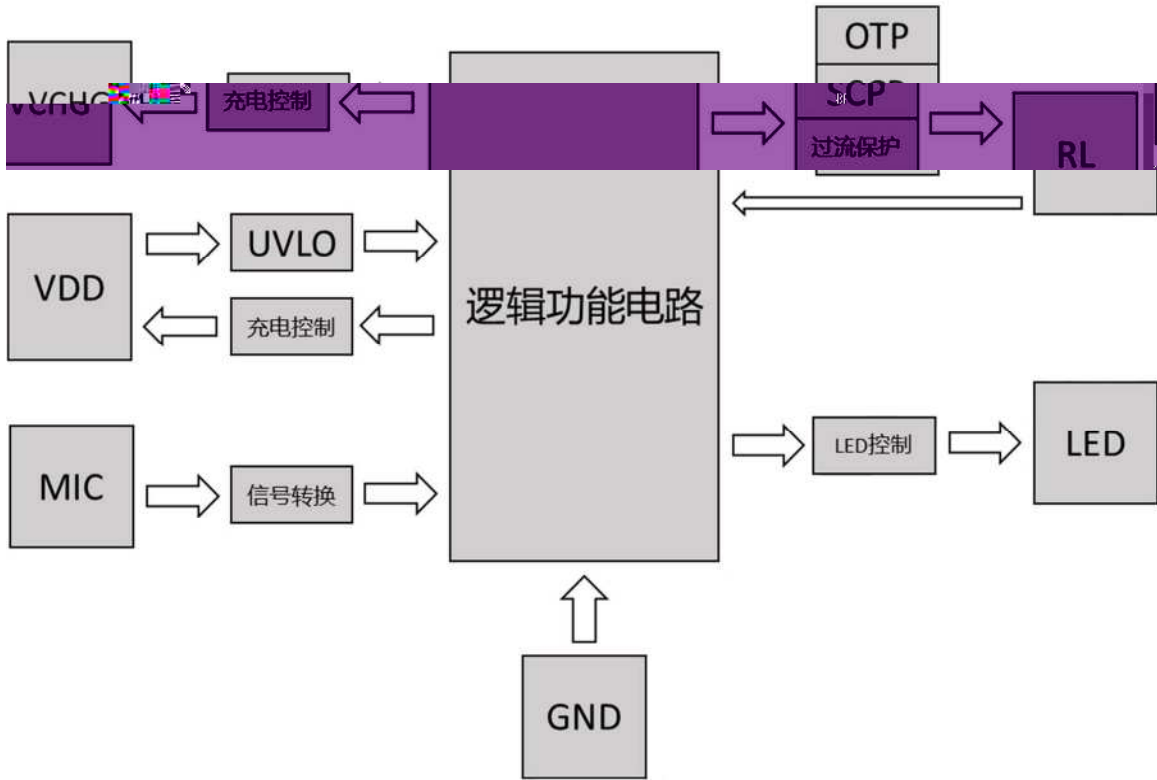

1.

2.

2.1

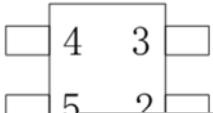

2.2

外形	序号	符号	功能描述
	1	VCHG	充电电源输入
	2	GND	地
	3	MIC	吸烟检测 (SENSOR)
	5	VOUT	接电热丝
	6	VDD/VCC	接电池正端

2.3

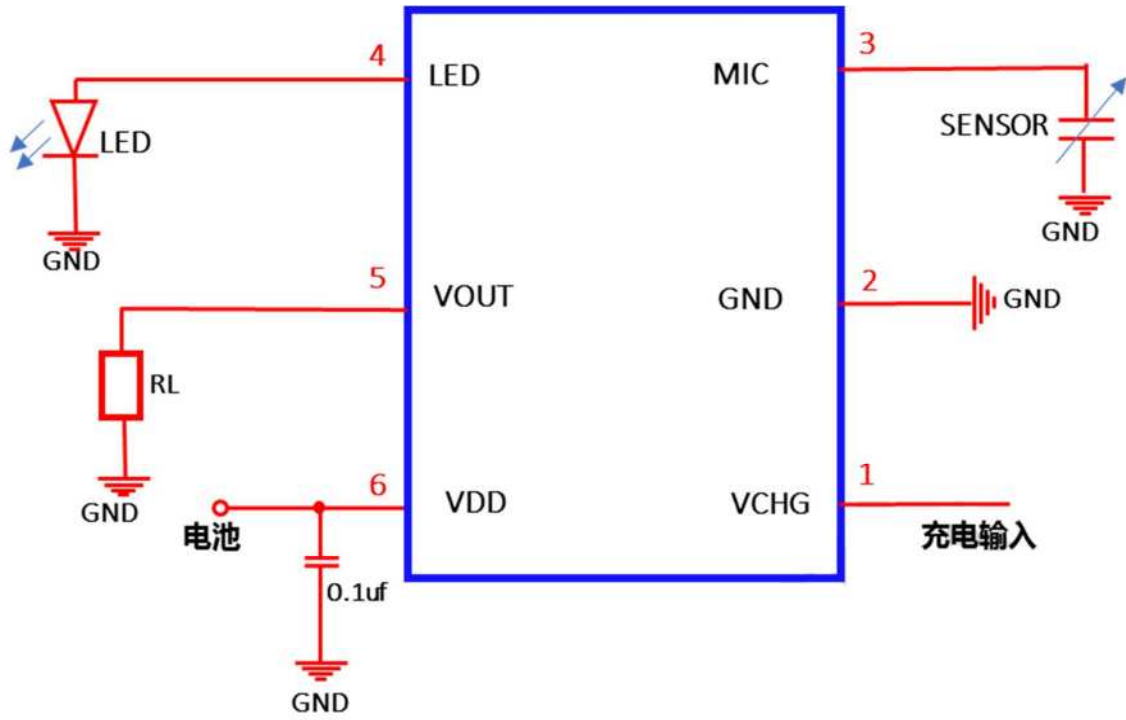

2.4

2.4.1

2.4.2 LED

2.4.3

2.4.4

OSC

2.4.5

2.5 LED

	LED



4.

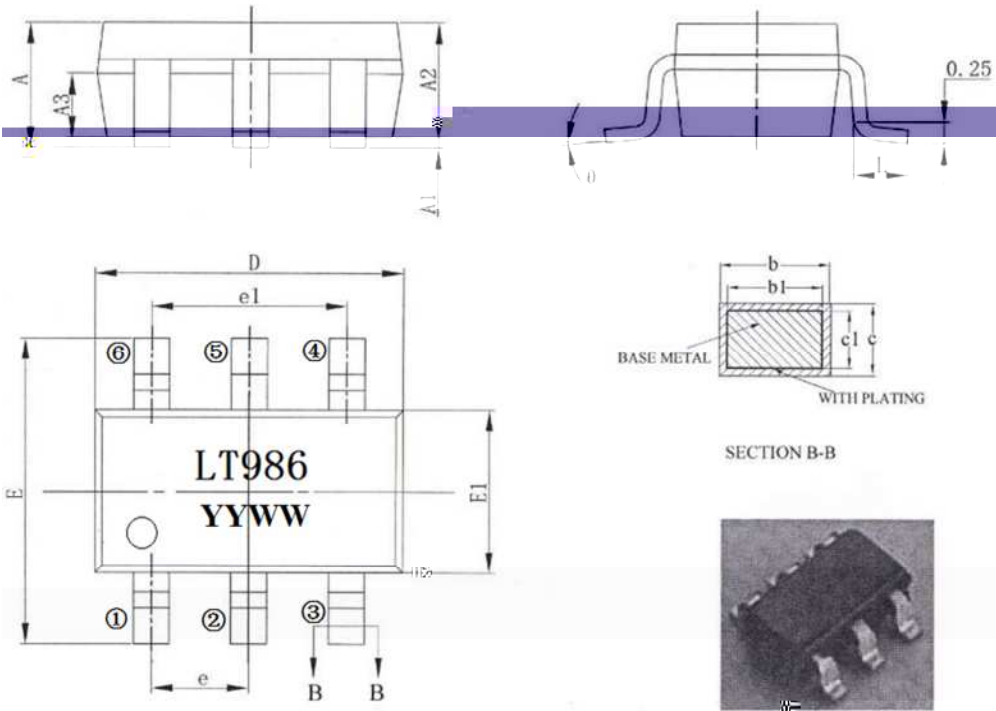

SYMBOL	MILLIMETER		
	MIN	NOM	MAX
A	—	—	1.25
A1	0.04	—	0.10
A2	1.00	1.10	1.20
A3	0.55	0.65	0.75
b	0.38	—	0.48
b1	0.37	0.40	0.43
c	0.11	—	0.21
c1	0.10	0.13	0.16
D	2.72	2.92	3.12
E	2.60	2.80	3.00
E1	1.40	1.60	1.80
e	0.95BSC		
e1	1.90BSC		
L	0.30	—	0.60
θ	0	—	8°

5.

5.1

3000PCS/

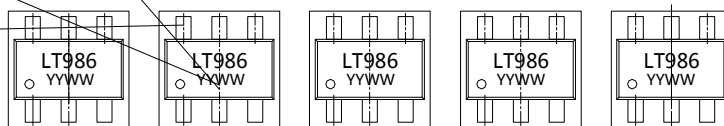

5.2

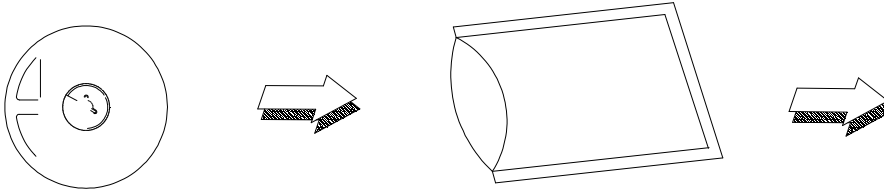

6.

Test Item	Test Condition	Test Time	Quantity	Ac/Re