

## SL-T2528RGBIC-L110 DATA SHEET

SPEC.NO. : SZ18092602  
DATE : 2018/09/26  
REV. : A/0

Approved By:

Checked By:

Prepared By:

%

&

,

(

)

.....

,

,

,

(





\*" D] b Zi bVh] cb

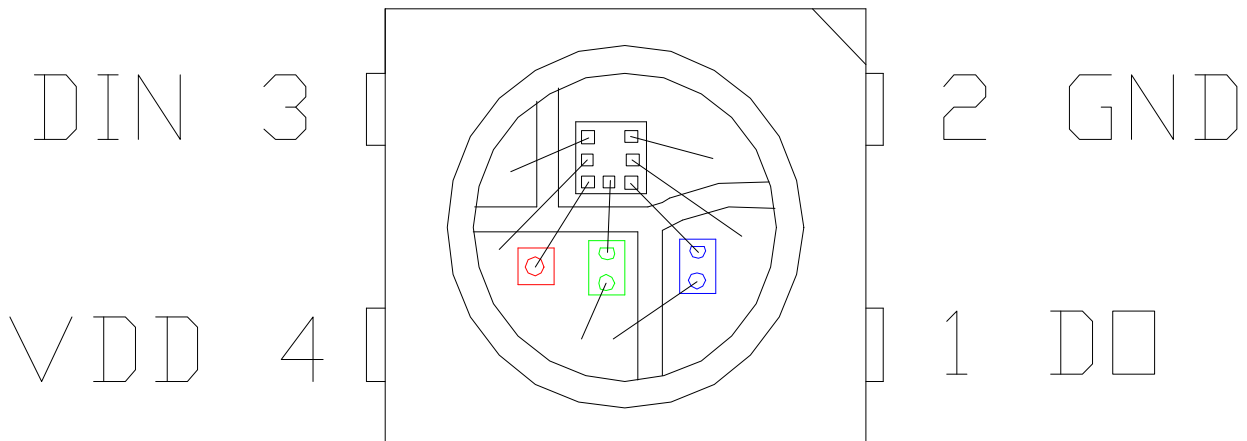

%	8C		
&	; B8		
'	8=B		
(	J88		D76

+ " 9` YVhfc! cdh] WU` VXUFUVhYf] gh] Vg Uh HU1&) F; 6

=hYa	GraVc`	A]I	Hrd	AUI	I b] h	7cbX] h] cbg
8ca] bUbh kUj Y` Yb[ h\	E` X	; )&\$		)&	ba	=: 1%&a5
		F *&\$		*&		
		6 (*)		(+\$		
@ a] bci g ] bhYbg] hm	=J	; , \$\$		%&\$\$	aVK	=: 1%&a5
		F &\$\$		(\$\$		
		6 % \$		' \$\$		

L

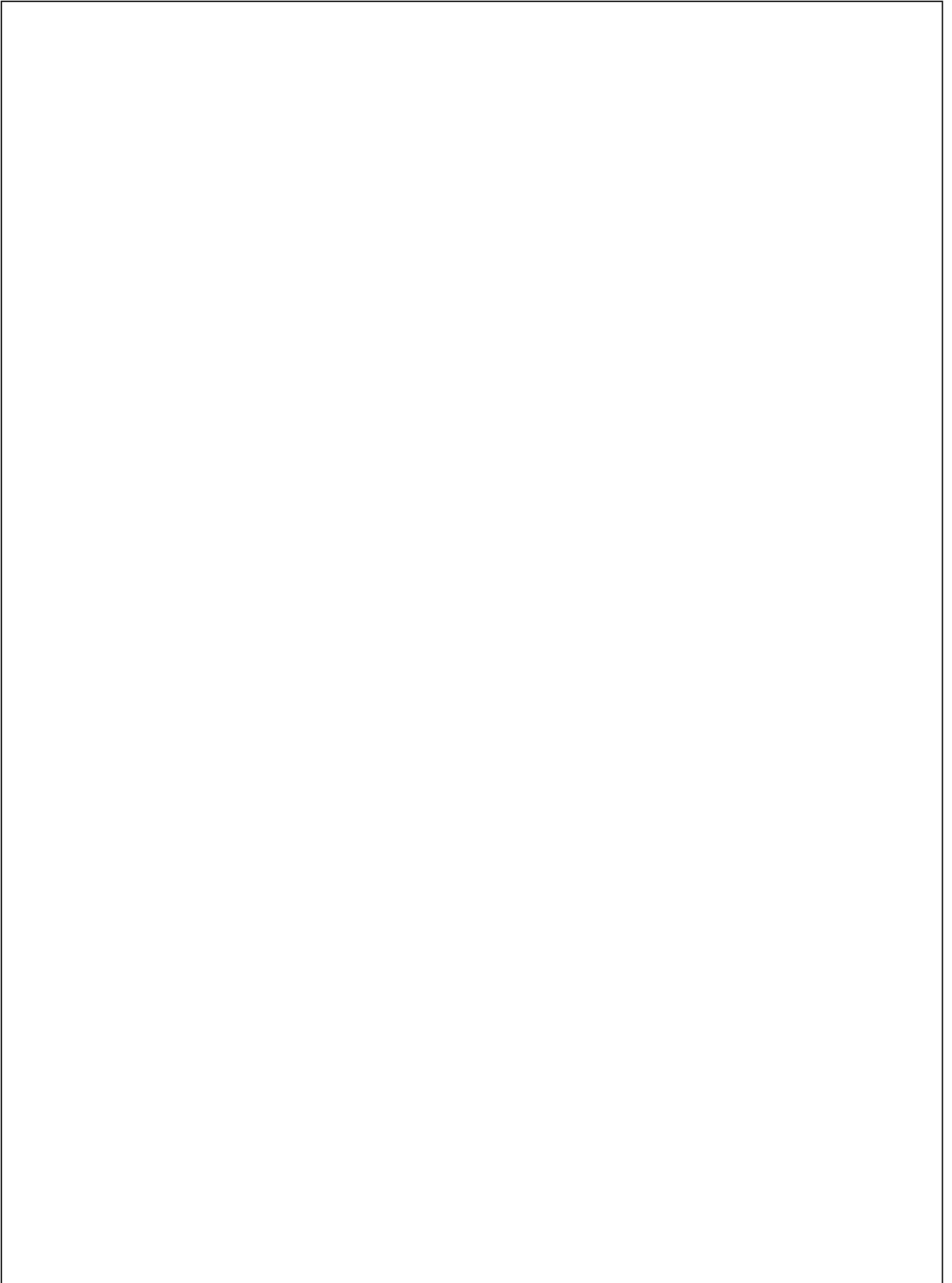

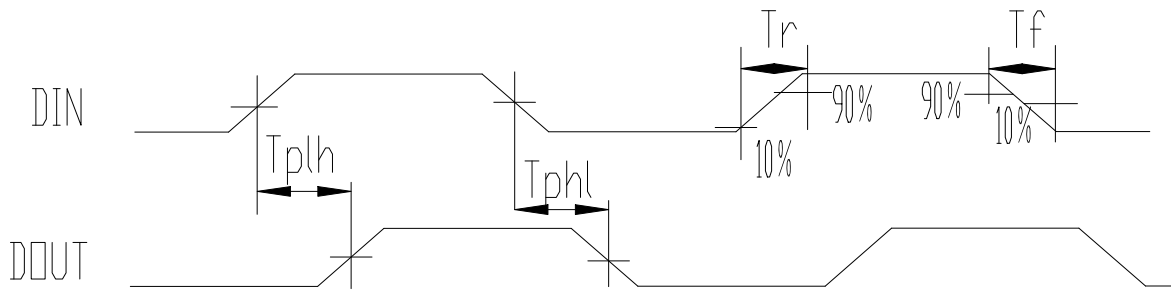

%% H\Y XUhU hfUbga] gg] cb h] aY

&) & F; 6=7					
H	7cXY	A] b	Hnd] WJ	AU	l b] h
HC<	\$	&()	&-)	'()	bg
HC@	\$	)()	)-)	*()	bg
H%<	%	)()	)-)	*()	bg
H%@	%	&()	&-)	'()	bg
Hfgh	FYgYh	, \$	!!	!!	i g

%%" HYadcfU` kUj YZcfa Z][i fY

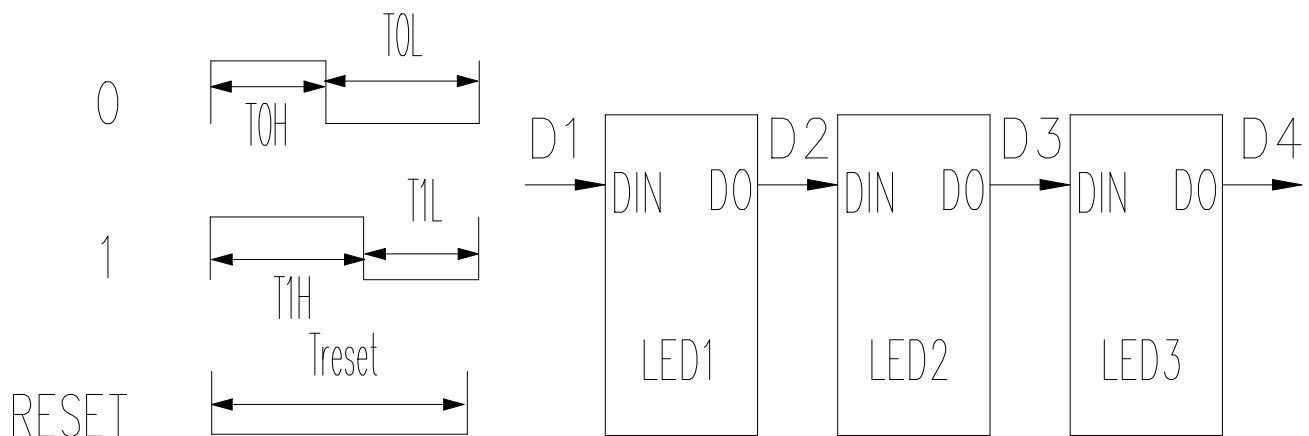

% " AcXY cZ XUhU hfUbga] gg] cb

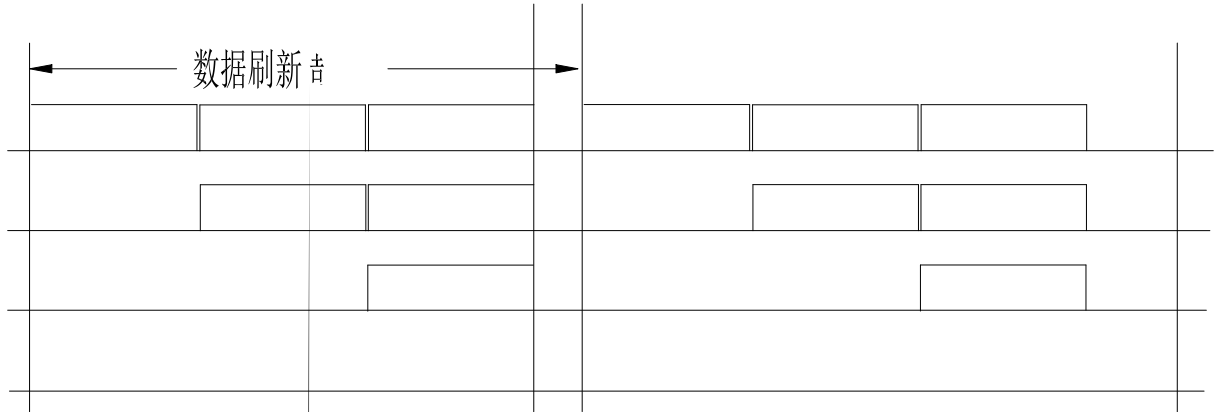



Gn

100%

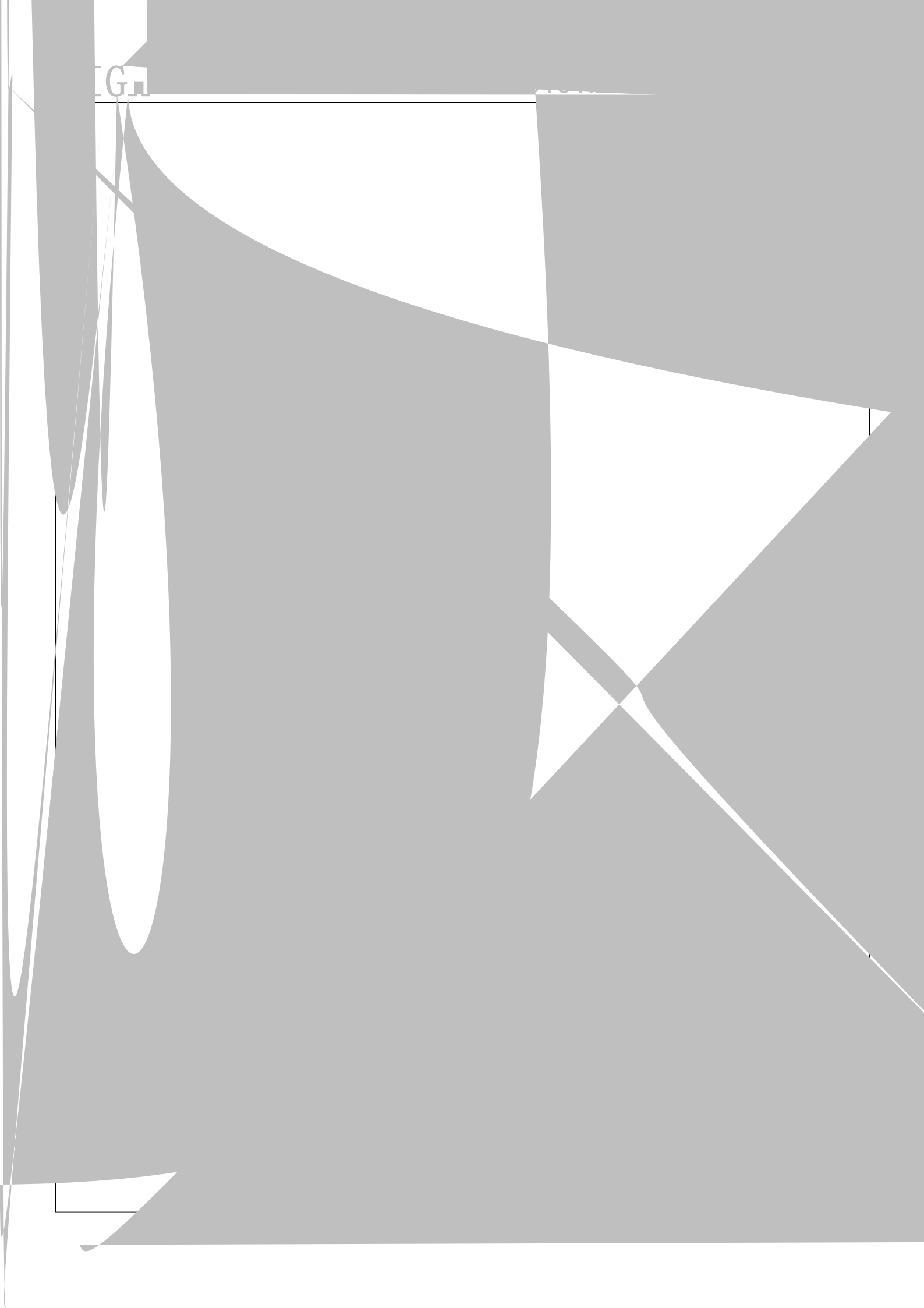

# LIGHT



%" DUW\_U[ ] b[ GdYV\ Z] W\h] cbg

: YXX] b[ 8] fYVh] cb

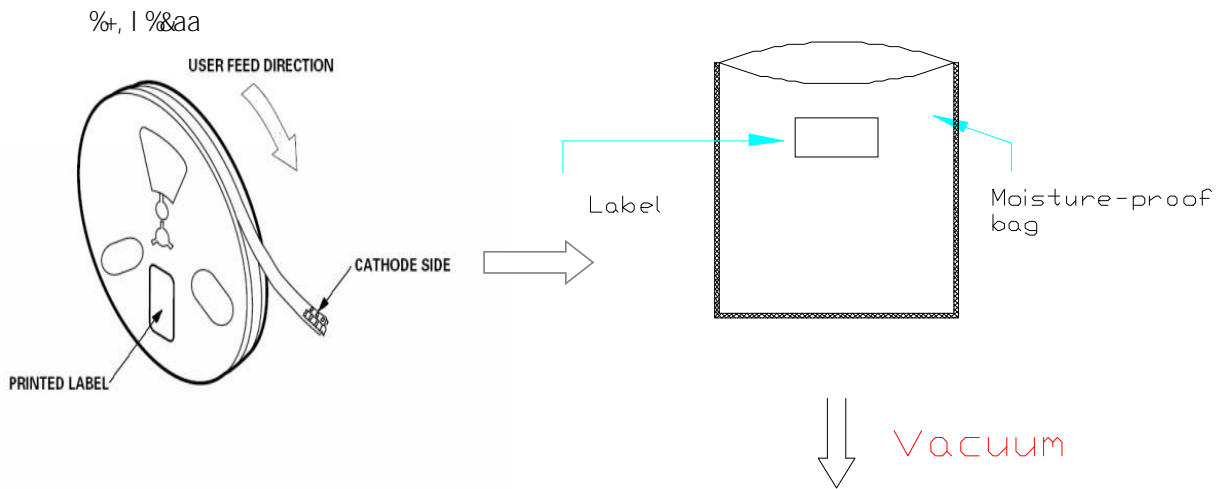
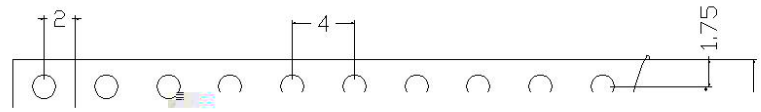

<b>LIGHT</b>	
Light Electronics CO., LTD.	
MODEL NAME: _____	 LOT NO.: _____
QUANTITY: _____	
BIN: _____	
PACKING DATE: _____	
CUSTOMER P/N: _____	

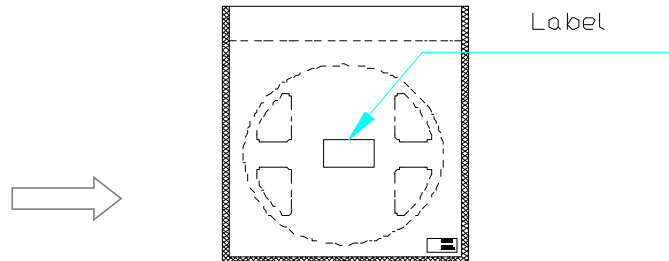

BchY. jc`iaY ]g &\$\$\$dVg/

&\$\$\$dVg

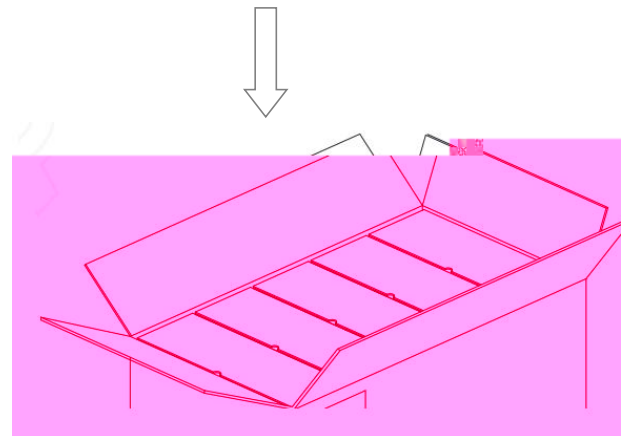

% " FY` ]U]` ]hm

H9GH =H9AG 5B8 F9GI @HG

	HYgh =hYa	FYZ" GhUbXUfX	HYgh 7cbX] h] cbg	BchY	7cbWi g] cb
%	FYZ` ck Gc` XYf] b[	>9G8&&! 6%\$*	Hg` X1&( \$ ž%\$gYW	' h] aYg	\$#&&
&	HYadYfUhi fY 7mWY	>9G8&&! 5%\$(	! &\$ ' \$a] b %&\$ ' \$a] b	&\$ \$ WmWY	\$#&&
,	HYfaU` G\cW_	>9G8&&! 5%\$*	! (\$ %&a] b %&) %&a] b	&\$ \$ WmWY	\$#&&
(	<] [\ HYadYfUhi fY GhcfU[ Y	>9G8&&! 5%\$'	H,1%\$\$	%\$\$\$ \fg	\$#&&
)	@ck HYadYfUhi fY GhcfU[ Y	>9G8&&! 5%%	H,1! (\$	%\$\$\$ \fg	\$#&&
*	DckYf hYadYfUhi fY 7mW] b[	>9G8&&! 5%\$)	Cb) a] b! (\$ 2%&a] b 0%&a] b CZZ) a] b%\$\$ 2%&a] b	&\$ \$ WmWY	\$#&&
+	@]ZY HYgh	>9G8&&! 5%\$,	H,1&) = 1%&a5	%\$\$\$ \fg	\$#&&
,	<] [\ <i a] X] hm <YUh @]ZY HYgh	>9G8&&! 5%\$%	*\$ F<1- \$i = 1%&a5	%\$\$\$ \fg	\$#&&

% " FYZ` ck dfcZ] `Y

GAB FYZ` ck Gc` XYf] b[ =bghfi Vh] cbg

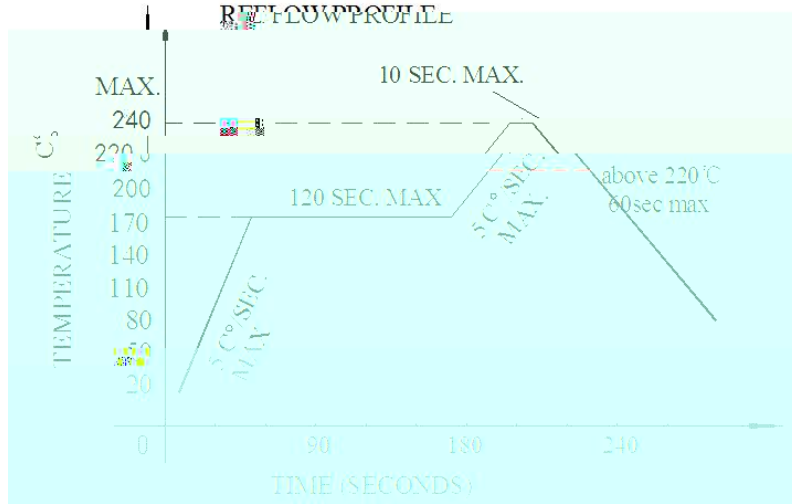

U" FYZ` ck gc` XYf] b[ g\ci `X bch VY XcbY acfY h\Ub hkc h]aYg

&

V" K\Yb gc` XYf] b[ žXc bch di h ghfYgg cb h\Y @98g Xi f] b[ \YUh] b[

@98

Gc` XYf] b[ ] fcb

U" K\Yb \UbX gc` XYf] b[ ž \_YYd h\Y hYadYfUhi fY cZ h\Y ] fcb i bXYf ' \$\$ ž UbX Uh h\Uh

hYadYfUhi fY \_YYd h\Y h] aY i bXYf ' gYW

' \$\$

V" H\Y \UbX gc` XYf] b[ g\ci `X VY XcbY cb` m U h] aY

FYkcf\_

U" 7i ghcaYf ai gh Z] b] g\ fYkcf\_ k] h\] b ) gYWi bXYf & (\$

& (\$ )

V" H\Y \YUX cZ ] fcb WUb bch hci WX h\Y @98g

@98

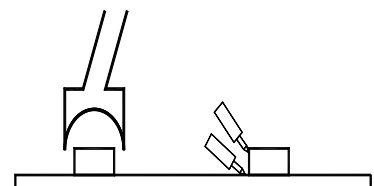

W Hk] b] \YUX hmdY ] g dfYZYffYX"

&\$" 75I H=CBG

## BchY Zcf i gY

=b cfXYf hc Ybgi fY h\Uh =7 `Uad VYUXg UfY i gYX ]b GAH dUhW\ fYZ` ck kY` X]b[ UbX ]b  
h\Y i gY cZ h\Y dfcWgg m]Y` X UbX ghUV]` ] hmcZ h\Y dfcXi Vhž h\Y Zc` `ck]b[ dfcWXi fYg UfY  
[REDACTED] UZhYf aUbm hYghg.

=7 GAH

U Glad` Y Yj U i Uh] cb. 6YWUi gY h\] g dfcXi Vh ]g U Vi ]` h! ] b =7 dfcXi Vhž h\Y cj YfU` ` dfcWgg  
]g X] ZZYfYbh Zfca Včbj Ybh] cbU` F; 6 dfcXi Vhž gc h\Y WghcaYf g] XY bYYXg hc Wffm ci h  
U` ! fci bX j Yf] Z] WWh] cb Xi f] b[ h\Y glad` Y Yj U i Uh] cb hc Ybgi fY h\Y aUhW\] b[ dYfZcfaUbW  
cZ h\Y dfcXi Vh

=7 F; 6

V =bVča]b[ aUhYf]U` ]bgdYWh] cb. Ybgi fY h\Y j UW i a dUW] b[ ]g ]bhUWh UbX h\YfY ]g bc  
j UW i a `YU\_U[Y" =Z h\YfY ]g j UW i a `YU\_U[Yž d` YUgY VčbZ] fa k\Yh\Yf h\Y fYZ` ck kY` X]b[ ]g  
UVbcfaU " =Z ]h ]g UVbcfaU ž d` YUgY fYhi fb hc h\Y ZUWhcfm Zcf \] [\! hYadYfUhi fY  
XY\i a] X] Z] WWh] cb"

W I gY. D` YUgY VčbZ] fa h\YY\ h a

X AU] bhYbUbW. aUhYf] U` g\ci ` X VY Wcad` YhYX k] h\] b ( \ci fg UbX XcaYgh] WXYaUbX UZhYf  
fYZ` ck gc` XYf] b[ hYgh UbX fYdU] f h\Y ` Uad VYUXž gi Wk Ug acfY h\Ub ( \ci fg bYYX hc fYdU] f  
h\Y ` Uad d` UhY hYadYfUhi fY UVcj Y \*) XY\i a] X] Z] WUh] cb %& \ci fg hc fYdU] f kcf\_ž UbX  
fYdU] f h\Y ` Uad VYUX U` gc ai gh Wffmcb h\Y ` ck hYadYfUhi fY UVcj Y \*) XY\i a] X] Z] WUh] cb  
%& \ci fgž i gY dfc\] V] hYX ] b h\Y dfcWgg cZ aU] bhYbUbW k] h\ hYadYfUhi fY cj Yf &(\$  
\Uh] b[ aUW] bY fYdU] fž dfc\] V] h h\Y k\c` Y d` UhY d` UWYX ] b h\Y \Uh] b[ ghU[Y fYdU] fž  
Zc` `ck h\Y df] bW] d` Y cZ VUX k\] Wk fYhi fb k\] Wk aYUgi f] b["

( ( \*) %& \*) %& &(\$

Y KUfa dfcadh. h\Y k\c` Y dfcWgg gdYW] U` Wcbg] XYfUh] cbg Zcf ` ] [\h VYUX VYZcfY i gY  
j UW] i a dUW] b[ž XY\i a] X] Z] WUh] cbž GAH d` UW] aYbh h] aY UbX kcf\_g\cd cZ hYadYfUhi fY UbX  
\i a] X] hmWcbhf c` ž dfcXi Wk aU] bhYbUbW ` Uad d` UhY ] Z VUFY Uh fcca hYadYfUhi fY Ybj ] fcbaybh  
Zcf U` cb[ h] aY bYYX hc XY\i a] X] Z] WUh] cbž ` ] [\h VcUFX UbX ` ] [\h VYUX ` ] [\h VYUXg Ug @98  
Y` YW] hfcb] WdfcXi Wkž bYYX hc dUm UhhYbh] cb hc ac] ghi fY ] b gdf] b[ UbX gi aaYfž Ui hi ab UbX  
k] bhYf Ubh] ! ghUh] Wž dfcXi Wk ei U ] hm] g YbhYf df] gYfig ` ] ZYž hc h\Y ei U ] hmghf] j Yg Zcf h\Y  
gi fj ] j U ž hc h\Y ei U ] hmghf] j Yg Zcf h\Y XYj Y` cdaYbh ] g ci f Wcbg] ghYbh U] a" 5` gc ] b cfXYf  
hc Ybgi fY h\Y ei U ] hmcZ h\Y W] Ybhž d` YUgY ghf] Wk` m fYZYf hc h\Y UVcj Y fYWcaYbXUh] cbg

@98

# LIGHT

