

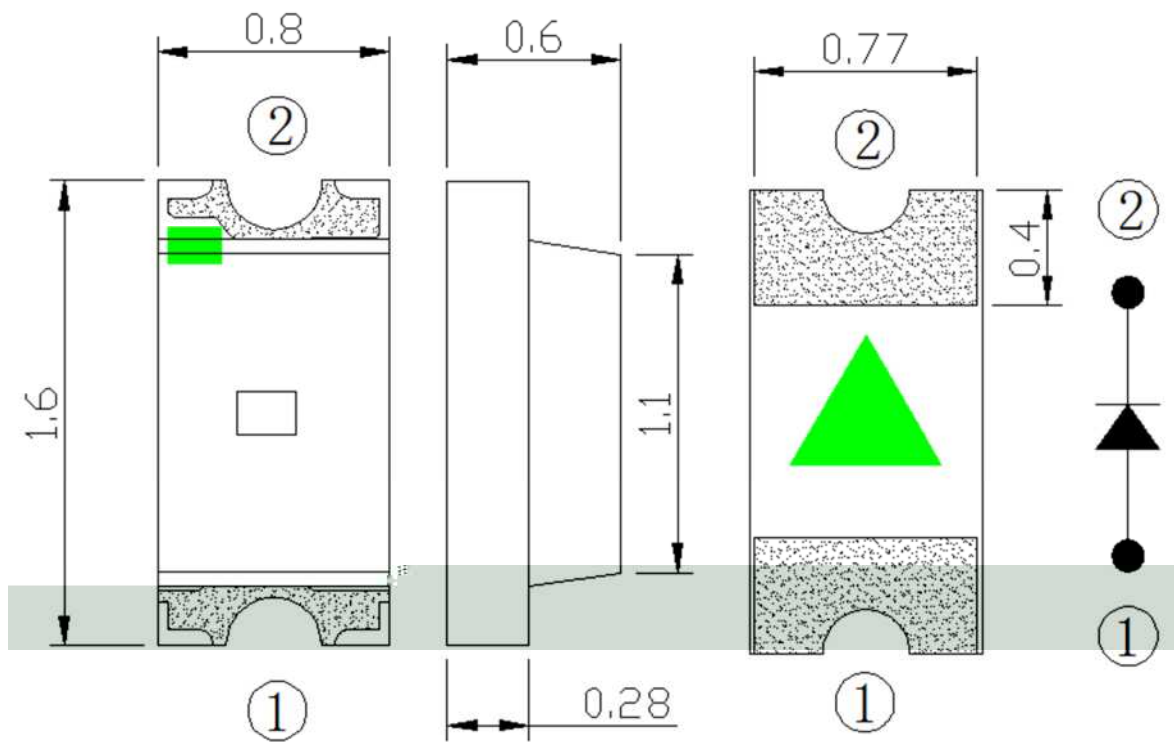

# LIGHT

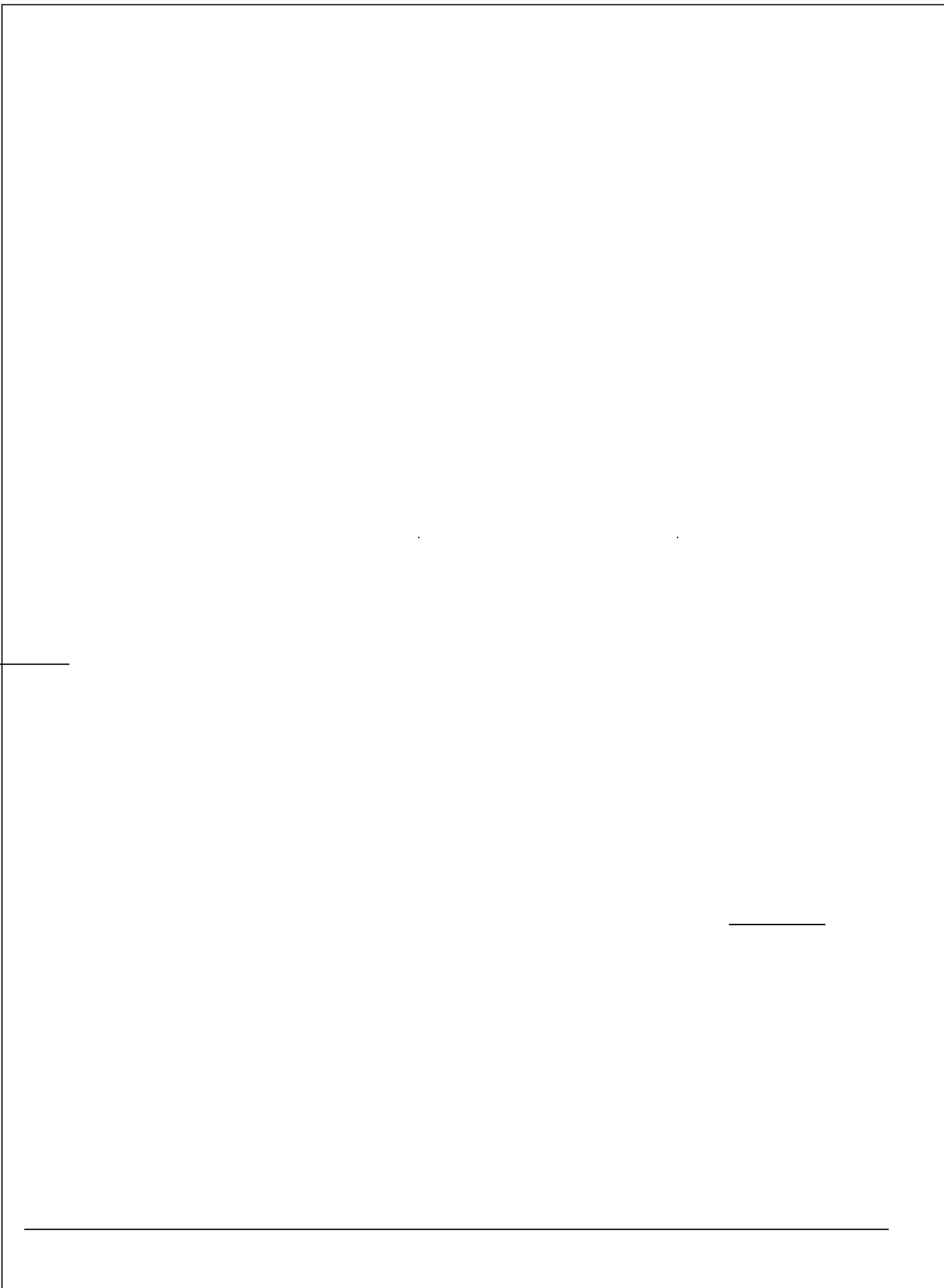

LIG



--	--	--	--

# LIGHT



--	--	--	--





## Label Explanation

**LIGHT** 深圳莱特光电股份有限公司  
Light Electronics CO., LTD.

TYPE NO. : \_\_\_\_\_  
QUANTITY : \_\_\_\_\_  
BIN : \_\_\_\_\_  
DATE CODE : \_\_\_\_\_  
REMARKS : \_\_\_\_\_

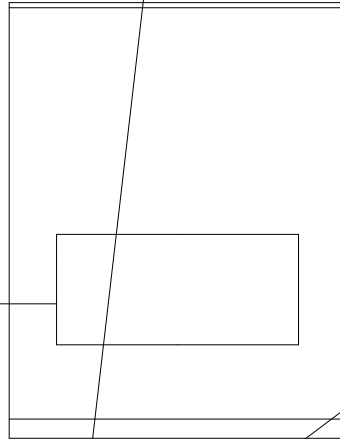
LOT NO. : \_\_\_\_\_



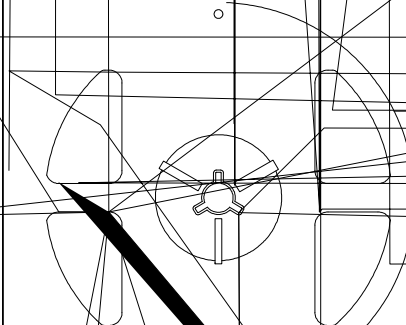

## Reel Dimensions

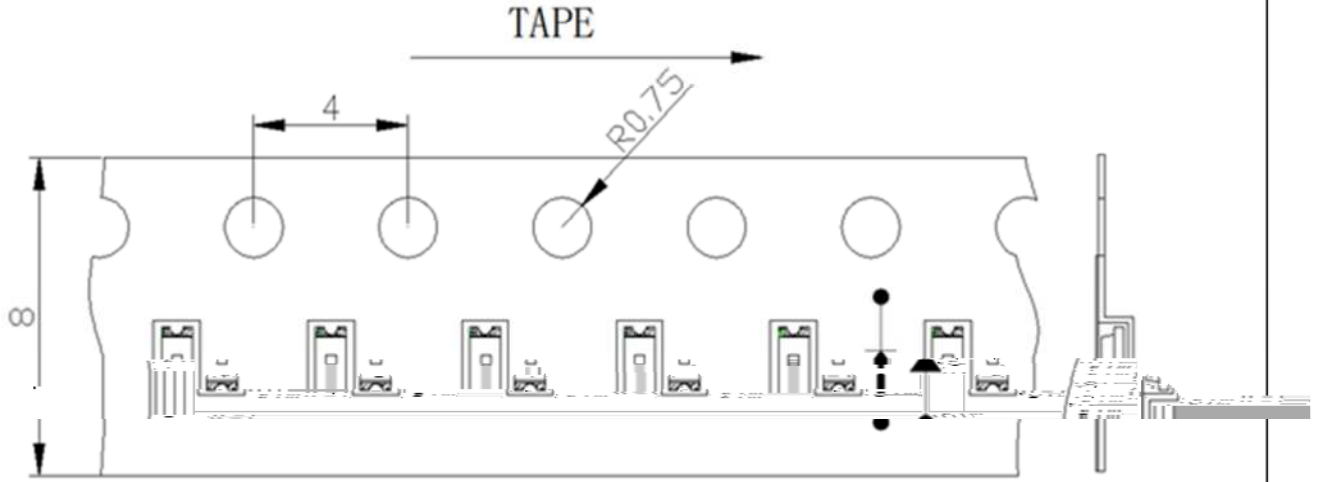

--	--	--	--

## Carrier Tape Specifications (Loaded Quantity: 4000pcs/reel)



## Moisture Resistant Packaging

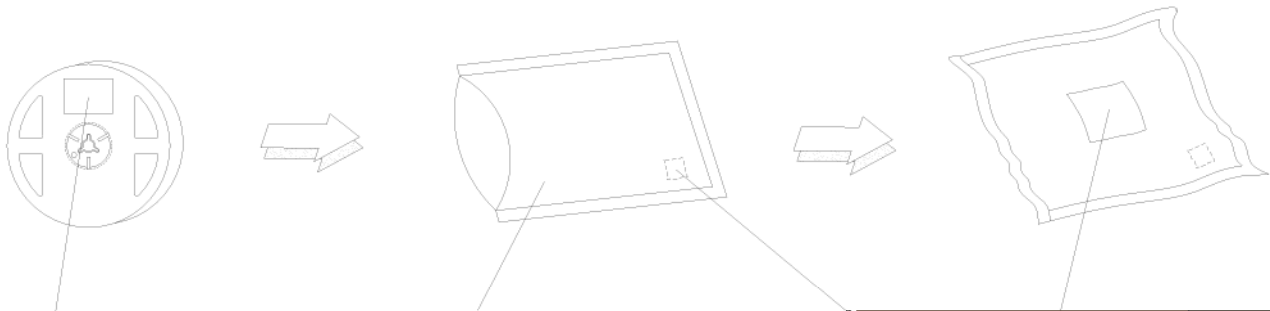

aluminum moisture proof bag      Desiccant      Label      Label      AD

### Suggest IR Reflow Condition For Lead Free

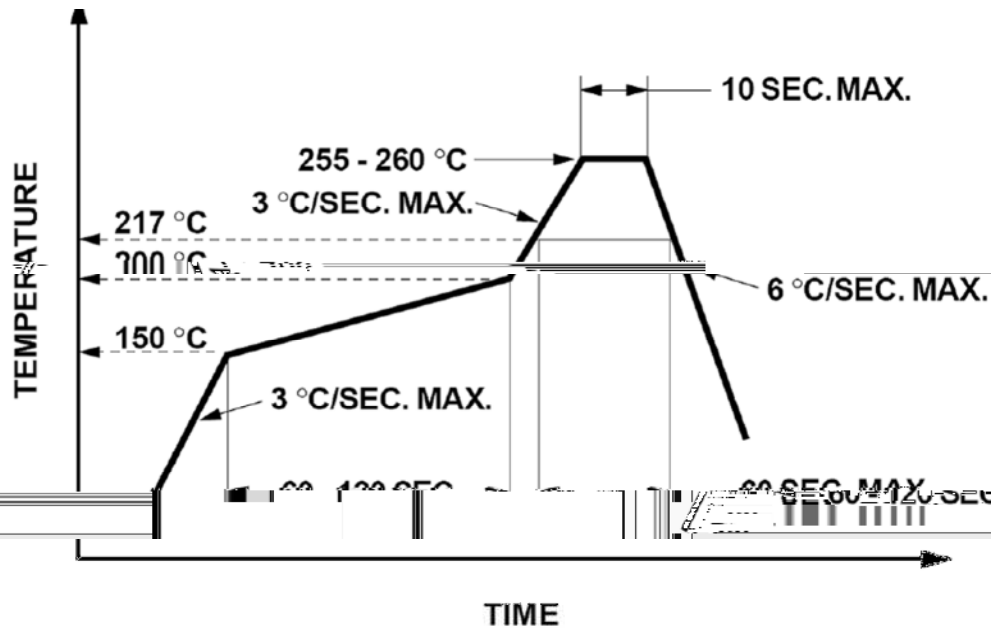

1. Reflow soldering should not be done more than two times.
2. When soldering, do not put stress on the LEDs during heating.

### Soldering iron

1. When hand soldering, the temperature of the iron must less than 300 °C for 3 seconds.
2. The hand solder should be done only once.

### Repairing

Repair should not be done after the LEDs have been soldered. When repairing is unavoidable, a double-head soldering iron should be used (as below figure). It should be confirmed beforehand whether the characteristics of LEDs will or will not be damaged by repairing.

