

SL-T1516RGBA-L150-N DATA SHEET

SPEC.NO. : SZ19101203
DATE : 2020/04/24
REV. : A/1

Approved By:

Checked By:

Prepared By:

SL-T1516RGBA-L150-N

TOP Full-color LED

Technical Data Sheet

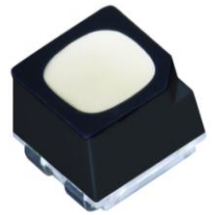

These products are full-color SMD components with black frame and white refractor, high contrast, matt packaging and non-mirror reflection, which are featured by multiple waterproof performance, good reliability, long lifespan and wide viewing angle. They are designed for outdoor display and decoration applications.

Features:

Material:	Red	Green	Blue
	AlGaInP	InGaN	InGaN

Encapsulation: Epoxy Resin

Soldering methods: Pb-Free reflow soldering

High Luminous Intensity ,Low Power Dissipation, good Reliability and Long Life

ROHS
Complied With ROHS Directive

Catalogue

Electrical Characteristics.....	2
Typical Characteristic Curves.....	3
Reliability Test Items and Conditions.....	4
Product design and operating recommendation.....	5
Packaging.....	6
Guideline for Soldering.....	8
Precautions.....	10

*

* The specifications of the product may be modified for improvement without notice.

Electro-Optical Characteristics

✧ Absolute Maximum Ratings (Temperature=25 °C)

Parameter	Symbol	Rating	Unit
Forward Current	I_F	25	mA
Pulse Forward Current*	I_{FP}	50	mA
Reverse Voltage	V_R	5	V
Operating Temperature	Tamd	-30 ~ +85	
Storage Temperature	Tstg	-40 ~ +100	
Power Dissipation	Red	62.5	mW
	Green	85	
	Blue	85	

* 0.1ms 1/10 * Note: Pulse Width 0.1ms, Duty 1/10

✧ Electro-Optical Characteristics (Temperature=25 °C)

Parameter	Symbol	Condition	Color	Min.	Typ.	Max.	Unit
Reverse Current	I_R	VR=5 V	Red			10	
			Green			10	
			Blue			10	
Forward Voltage	V_F	IF=15mA	Red	1.8	2.1	2.5	V
		IF=8mA	Green	2.4	2.9	3.4	
		IF=5mA	Blue	2.4	2.9	3.4	
Dominant Wavelength	λ_D	IF=15mA	Red	615	622	630	nm
		IF=8mA	Green	515	528	540	
		IF=5mA	Blue	460	469	480	
Spectrum Radiation Bandwidth		IF=15mA	Red			24	nm
		IF=8mA	Green			38	
		IF=5mA	Blue			28	
Luminous Intensity	I_V	IF=15mA	Red	200	370	560	mcd
		IF=8mA	Green	320	560	850	
		IF=5mA	Blue	40	80	130	
View Angle	2 1/2				110		deg.

以上 厂商

manufacturer

Typical Characteristics Curves

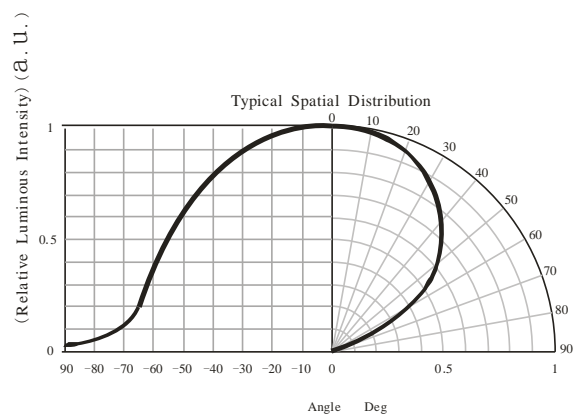
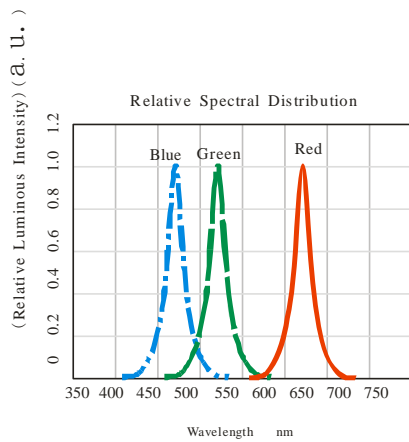
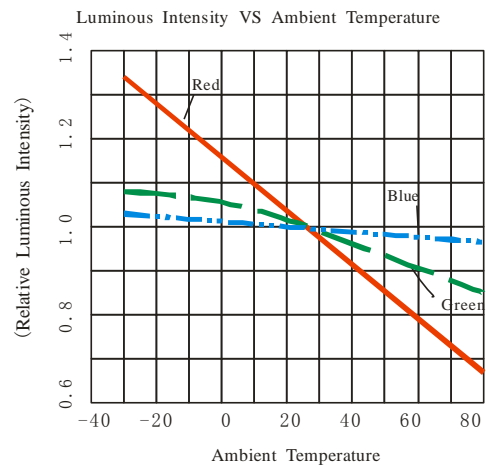
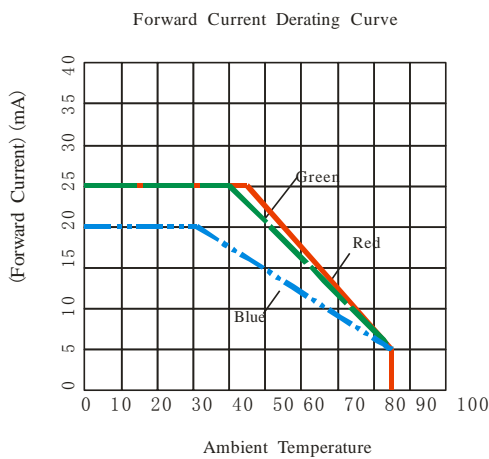
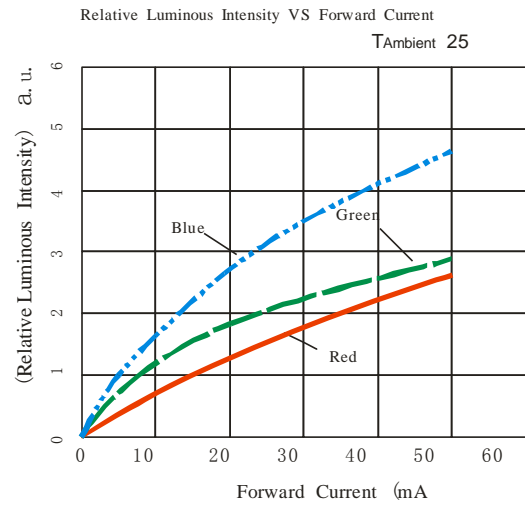
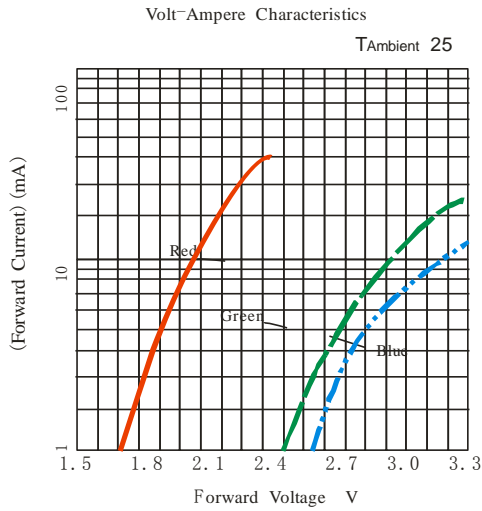

Product Design and Operating Recommendation

1 mm

Product design Unit: mm

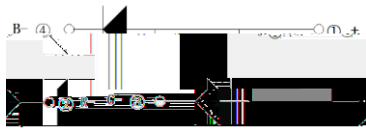
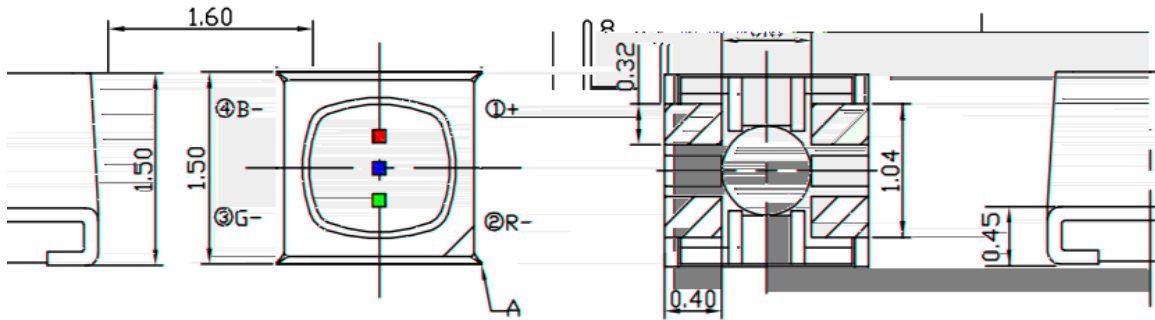

Polarity

Note

A
A Nick Mark
X.X 0.1 mm X.XX 0.05mm
Tolerances X.X 0.1 mm X.XX 0.05mm

2 mm

Reference soldering pad (Unit: mm)

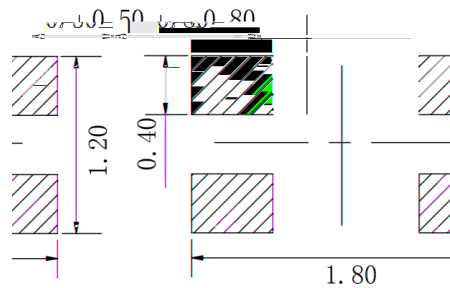

3 0.60mm

Recommendation for glue filling: filling height must be higher than or equal to 0.60mm

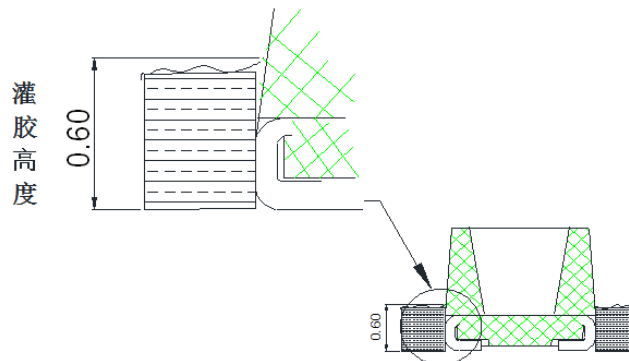

LIGHT



✧ **Cardboard Box**

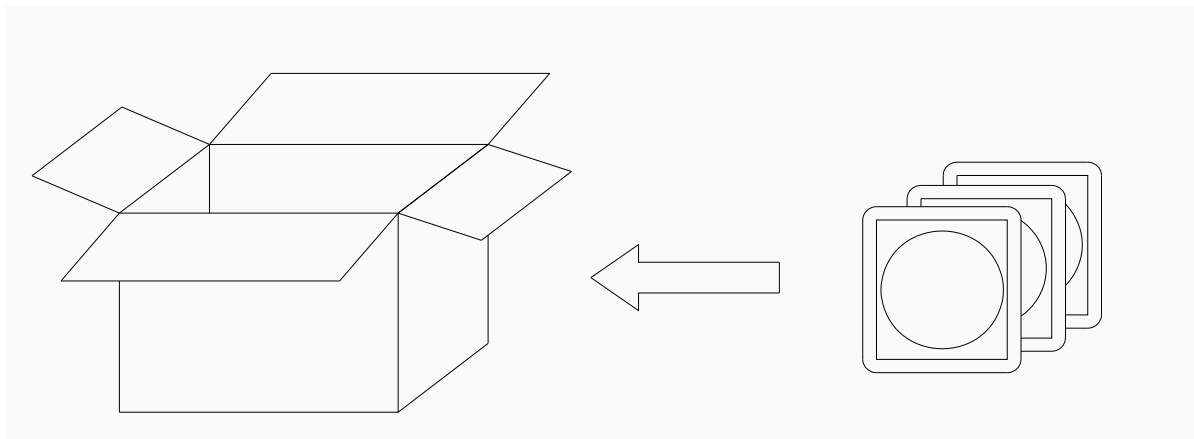

✧ **Label Explanation**

LIGHT_L

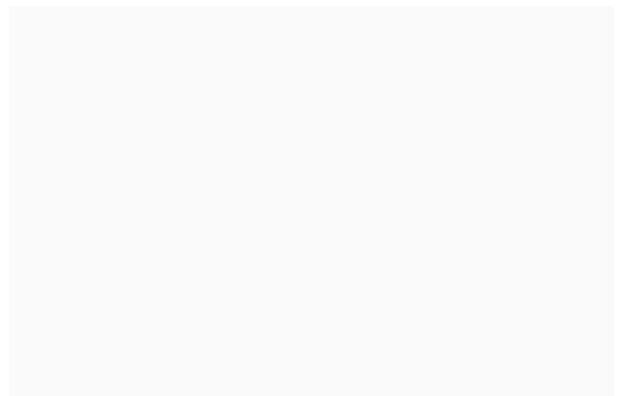

116

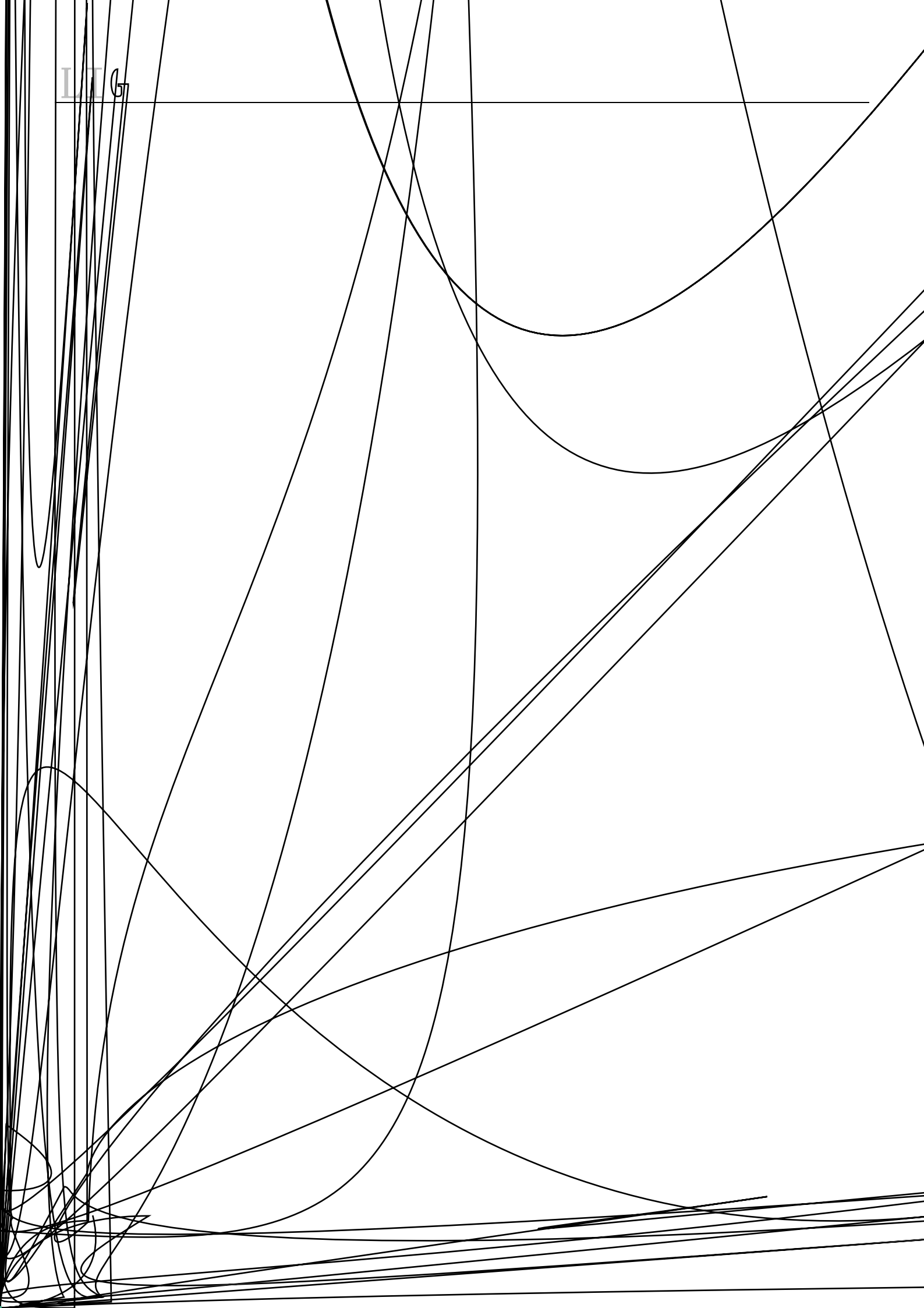

佛 (1)

Precautions (1)

1.

Storage

•

Moisture proof, anti-electrostatic package and moisture absorbent material are used, to keep moisture to a minimum. Humidity indicator card inside to test if the products are moisted.

•

<30 <60 RH

Storage environment: All the products should be stored in the environment of temperature<30 and humidity<60 RH before foiled bags open and need to be baked before SMT.

•

Before using, please check whether there is any air leakage or not, If the bag has leaked air, Please bake the product with below condition.

•

<30 <60 RH 8h

Before soldering ,the product must be stored under the condition of <30 and <60 RH. Under these conditions the SMD LEDs must be used (subject to reflow oven) within 8 hours.

•

70±5 12h

70±5 24h

6 70±5 48h

Baking condition storage undamped : 70±5 ×12h

e (undamped): 70±5 ×24h

Damped/Foiled bag leakage/ beyond 6 months storage at customers side: 70±5 ×48h

2.

Static Electricity

•

LIGHT

佛 (3)

Precautions (3)

Such as the reverse current increase rapidly. And it will cause the string light when the screen is black. So please pay attention to controlling the reverse voltage which less than 5V is recommended.

5.

The safe temperature for LEDs working

- LED

55

75

The high temperature will make are used in hot environment for a long time, they will be disabled easily. When LEDs are used in a high density array, we suggest that the LEDs and the lower than 75 .

6.

Others

-

When handling the product, touching the encapsulation with bare hands will not only contaminate its surface, but also have an effect on its optical characteristics. Excessive force to the encapsulation might result in catastrophic failure of the LEDs due to die breakage or wire deformation. For this reason, please do not put excessive stress on LEDs, especially when the LEDs are heated such as during Reflow Soldering.

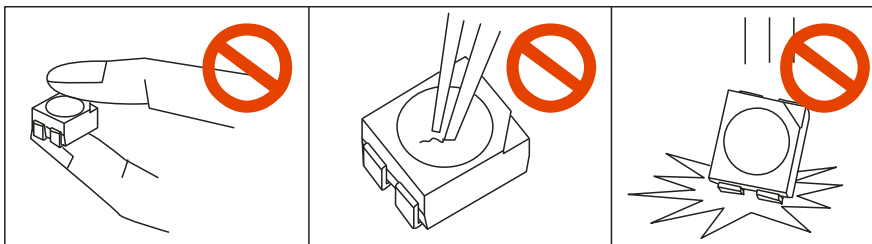

- LED

The epoxy resin of encapsulation is fragile, so please avoid scratch or friction over the epoxy resin surface. While handling the product with tweezers, do not hold by the epoxy resin, be careful.